



Slovak University of Technology in Bratislava

Faculty of Mechanical Engineering



Edited by: Miroslav Bošanský

Miroslav Nagy

Ján Danko

Roman Protasov

Šport Hotel\*\*\* Donovaly September 10<sup>th</sup> – 12<sup>th</sup>. 2025



The publication contains abstracts of papers submitted to the 65<sup>th</sup> International Conference of Machine Design Departments 2025, held at the Donovaly, September, on 10 - 12<sup>th</sup>

Individual authors are fully responsible for content of their abstracts. No language correction or technical processing was done before printing.

© Institute of Automotive engineering and designing and authors

Published by:

SMME-STU, s.r.o.

Vazovova 5

812 43 Bratislava

© 2025 ÚAIK Sjf STU v Bratislave

1st edition, electronic edition

Number of pages: 62

ISBN 978-80-974838-3-8

The 65<sup>th</sup> International Conference of Machine Design Departments 2025 is organized under the auspices of His Spectabilitis Lubomír Šooš, Assoc. Prof., dean of Faculty of mechanical Engineering, Slovak University of Technology in Bratislava.

**International Scientific Committee of the 65<sup>th</sup> ICMD 2025**

Tibor Balogh, HU  
Pavel Beňo, SK  
Miroslav Bošanský, SK  
Mehmet Bozca, TR  
Jozef Bronček, SK  
František Brumerčík, SK  
Ján Danko, SK  
Peter Droppa, SK  
Vojtech Dynybyl, CZ  
Robert Grega, SK  
Gurkan Gurdil, TR  
Andrzej Harlecki, PL  
Martin Hartl, CZ  
David Herák, CZ  
Stanislav Hosnedl, CZ  
Slavomir Hrček, SK  
David Hui, US  
Roland Jančo, SK  
Juliana Javorová, BG  
Milan Kadnár, SK  
Luboš Kučera, SK  
Marián Kučera, SK  
Václava Lašová, CZ  
František Lopot, CZ  
Luboš Magdolen, SK  
Josef Maščenik, SK  
Marcin Matuszak, PL  
Štefan Medvecký, SK  
Tomáš Milesich, SK  
Miloš Némček, CZ  
Frantisek Novy, SK  
Dajbych Oldřich, CZ  
Juraj Ondruška, SK  
Balázs Pere, HU  
Lubomir Pešík, CZ  
Karel Petr, CZ  
Michal Petrů, CZ  
Roman Protasov, SK  
Milan Rackov, SRB  
Stephen Radzevich, US  
Aleksander Sladkowski, PL  
Michael Storchak, DE  
Lubomir Ševčík, CZ  
Milan Tica, BIH  
Mykola Tkachuk, UA  
Miroslav Trochta, CZ  
Oleksandr Ustinenko, UA  
Václav Vaněk, CZ  
Miroslav Vereš, SK  
Nenad Zrnic, SRB

**The scientific conference covers the following areas:**

Machine Design and Innovation

Automotive Engineering

Tribology

Hydraulics, Fluid Mechanisms

Construction Engineering

Mechanical Engineering in Civil Construction

Modern Materials and Nanotechnology

Optimisation and Design

Product Innovation

Experimental Methods and Measuring

Biomechanics

Autonomous Systems, Robotics, AI

Electromobility, Hydrogen Propulsion and other related topics



## ENHANCING BRAKE STABILITY IN FLOATING CALIPER BRAKE ASSEMBLY THROUGH COMPLEX EIGENVALUE ANALYSIS: A WEIGHTED BOLT APPROACH

BEŇO Pavel<sup>1</sup>, BRODNIANSKÁ Zuzana<sup>1</sup>, LIPNICKÝ Marek<sup>1</sup>

<sup>1</sup> Faculty of Technology, Technical University in Zvolen, Department of Mechanics, Mechanical Engineering and Design, Študentská 26, 960 01 Zvolen, Slovakia

This study demonstrates the application of Complex Eigenvalue Analysis (CEA) to optimize a weighted bolt that targets unstable frequencies in a floating caliper brake assembly (Fig.1). Modal analysis, a commonly used complex eigenvalue extraction method based on finite element analysis, is employed to predict brake instability in the context of NVH (Noise, Vibration, and Harshness). Unstable modes are known to contribute to brake squeal, as evidenced by previous research. In this investigation, a weighted bolt design is proposed to address the unstable modes. A commercial automobile brake assembly undergoes experimental modal analysis, and a corresponding finite element model is developed. The weight, a key design parameter, is examined along with different bolt placements to assess their impact on brake stability. The experimental and analytical models are compared, and a modal assurance criterion matrix is established based on relevant modes. Mass modifications are implemented, and the obtained results are presented. The brake assembly under study is a common vented disc brake, and the designs are analyzed using Abaqus software.

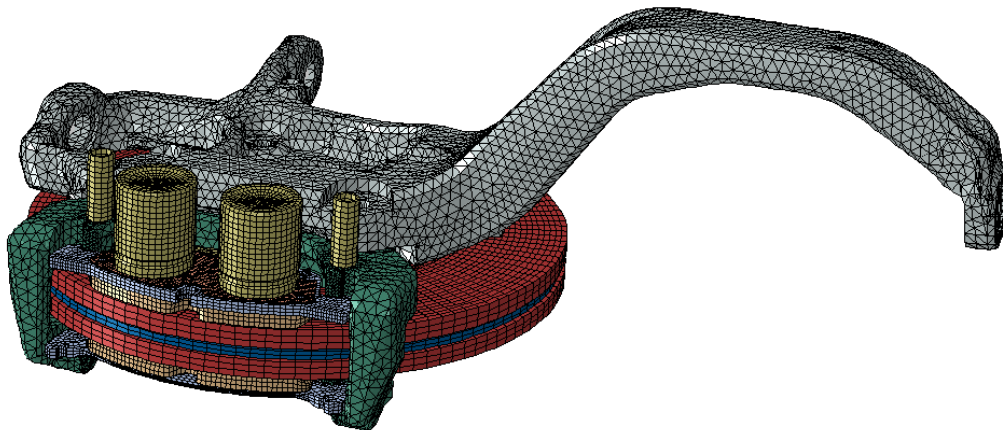

Fig. 1 Finite element model of a vented floating caliper disc brake assembly.

### REFERENCES

- [1] Park, J.S., Lee, J.C., Cho, S., Yoon, K. Reduction of Brake Squeal Analyzed in Terms of Coupling Between In-Plane and Out-of-Plane Modes. SAE International Journal of Passenger Cars - Mechanical Systems 2012, 5, 1230–1243. <https://doi.org/10.4271/2012-01-1828>
- [2] Liles, G.D. Analysis of Disc Brake Squeal Using Finite Element Methods. In Proceedings of the SAE Noise and Vibration Conference and Exposition, 1989, p. 891150. <https://doi.org/10.4271/891150>
- [3] Denimal, E., Sinou, J.J., Nacivet, S., Nechak, L. Squeal Analysis Based on the Effect and Determination of the Most Influential Contacts between the Different Components of an Automotive Brake System. International Journal of Mechanical Sciences 2019, 151, 192–213. <https://doi.org/10.1016/j.ijmecsci.2018.10.054>
- [4] Pastor, M.; Binda, M.; Harčarik, T. Modal assurance criterion. Procedia Engineering 2012, 48, 543–548.

# CONCEPT OF A PARAMETRIC SIMULATION WORKFLOW FOR RUBBER-METAL MOUNTS IN ELECTRIC DRIVETRAIN APPLICATIONS

**BERNÁTH Martin<sup>1</sup>, DANKO Ján<sup>1</sup>, BUCHA Jozef<sup>1</sup>, DOBROVOLNÝ Juraj<sup>1</sup>**

<sup>1</sup> Faculty of Mechanical Engineering, Slovak University of Technology in Bratislava, Institute of Automotive Engineering and Design, nám. Slobody 17,812 31 Bratislava, Slovakia, e-mail: martin.bernath@stuba.sk

This paper focuses on developing a new method of designing and validating rubber-metal electric drivetrain mounts in electric and hybrid vehicles, aiming to reduce noise and vibration transmission. The aim of this method is to speed up simulations and improve their accuracy by using parametric multibody simulation models (MBS), combined with Functional Mock-up Units (FMU). The method targets NVH (Noise, Vibration, Harshness) [1] issues caused by electric motors, especially high-frequency vibrations [2]. Rubber-metal mount elements are optimized using MATLAB-Simulink and implemented into ADAMS View MBS simulations. Look-Up Tables (LUTs) are used to describe the frequency-dependent behaviour of rubber components, allowing practical and efficient parameter adjustment. Additionally, the Bouc-Wen hysteresis model is implemented in the simulation environment to account for nonlinear and energy-dissipating behaviour of the mounts under cyclic loading [3]. Key advantage of this method is the ability to flexibly modify input parameters and simulate different configurations without rebuilding the entire model. In addition, the method is prepared to be used in conjunction with reduced order models of said rubber-metal components [4]. This greatly reduces preparation time, minimizes human error, and supports automated simulations to generate training data for reduced-order models or neural networks of the entire drivetrain assembly, enabling further development of efficient NVH simulation tools for electric vehicles.

## ACKNOWLEDGMENT

This research was supported by the Slovak research and Development Agency under Contract No. APVV: SK-SRB-23-0024

## REFERENCES

- [1] Heiing, B., Ersoy, M. "Chassis Handbook – Fundamentals, Driving Dynamics, Components, Mechatronics, Perspectives". 1<sup>st</sup> edition, Springer Verlag, Berlin, Germany, 2011. ISBN 978-3-8348-0994-0
- [2] Bernáth, Martin. Analýza a návrh uloženia zadnej elektrickej hnacej sústavy vozidla E-up Boost. 2023. Diplomová práca. Slovenská technická univerzita v Bratislave, Strojnícka fakulta.
- [3] Ismail, M., Ikhouane, F., Rodellar, J.: The Hysteresis Bouc-Wen Model, a Survey. Arch Comput Methods Eng, 2009, roč. 16, s. 161–188. DOI: 10.1007/s11831-009-9031-8
- [4] Dobrovolný, J. "Návrh inovatívnej metodiky pre vývoj gumokovového prvku uloženia elektrickej hnacej sústavy". Slovak University of Technology in Bratislava, Faculty of Mechanical Engineering, Institute of Automotive Engineering and Design. Master thesis. [20.5.25], 2024.

# **INVESTIGATION OF THE POSSIBILITY OF MODERNIZING EXISTING PLANETARY GEARS THROUGH THE USE OF GEARS WITH HCR ENGAGEMENT**

**BOŠANSKY Miroslav<sup>1</sup>, PROTASOV Roman<sup>1</sup>, ONDRUŠKA Juraj<sup>1</sup>  
VORONTSOV Borys<sup>2</sup>, SOPRUNOV Igor<sup>3</sup>**

<sup>1</sup> Faculty of Mechanical Engineering, Slovak University of Technology in Bratislava, Institute of Automotive Engineering and Design, Nám. slobody 17, 812 31 Bratislava, Slovakia

<sup>2</sup> Education and Research Institute of Mechanical Engineering, National Technical University of Ukraine "Igor Sikorsky Kyiv Polytechnic Institute", Beresteyskiy prosp., 37, Kyiv, 03056, Ukraine

<sup>3</sup> Institute of Education and Science in Mechanical Engineering and Transport, National Technical University "Kharkiv Polytechnic Institute", 61002 Kharkiv, Ukraine

This study focuses on the application of gear transmissions with modified tooth profile geometry in agricultural machine transmissions, particularly in wheeled tractors. The modification involves replacing standard involute gear meshing with HCR (High Contact Ratio) [1] gearing in the planetary transmission of the wheel (final) drive.

Modernization of transmissions for agricultural machines represents a complex task. Modernization pursues several objectives: increasing engine power, extending service life, and reducing noise. When it is possible to modify certain reducer dimensions (such as width), the mass can be significantly reduced, which is particularly important for agricultural machinery [2].

The objective of this work is to evaluate the possibility of increasing transmitted torque, service life, and reducing noise in the wheel reducer of the heavy wheeled tractor K-700 using gears with HCR meshing. HCR transmissions are characterized by a transverse contact ratio exceeding 2.02 in spur gears. This ensures torque transmission through two or three tooth pairs simultaneously, significantly reducing contact stresses – the key factor limiting transmission load capacity. An additional advantage is noise reduction during operation. It is essential to carefully control the following geometric parameters: tooth tip sharpening, root undercutting, and interference.

The wheel reducer represents a single-stage planetary transmission with a gear ratio of 6, located in the wheel hub. Within the scope of modernization, it is proposed to maintain gear width and center distance. Variable parameters include: module, number of teeth, and corresponding tooth correction parameters to ensure the specified center distance. Controlled parameters include: contact pressure, specific sliding velocity in meshing, and bending stress at the tooth root. All calculations are performed using KISSsoft software. The calculation results will allow evaluation of the effectiveness and rationality of applying HCR gearing in the existing reducer based on comparison with conventional gears according to main strength and operational characteristics.

The research presented in this paper is an outcome of the project VEGA No. 1/0708/24 "Research on the design parameters of the high-speed spinning spindle of the progressive concept".

## **REFERENCES**

- [1] Vereš, M., Bošanský, M. Teória čelného rovinného ozubenía. Bratislava: Slovenská technická univerzita v Bratislave. 1999.
- [2] Jenis, J., Ondriaga, J., Hreck, S., Brumerčik, F., Cuchor, M., Sadovsky, E. Engineering Applications of Artificial Intelligence in Mechanical Design and Optimization. Machines. Vol.11 Issue 6, 2023, DOI:10.3390/machines11060577

## VIRTUAL MODEL OF THE KYBURZ VEHICLE USING THE FMI STANDARD

BUCHA Jozef<sup>1</sup>, DANKO Ján<sup>1</sup>, MAGDOLEN Ľuboš<sup>1</sup>

<sup>1</sup> Faculty of Mechanical Engineering, Slovak University of Technology in Bratislava, Institute of Automotive Engineering and Design, Nám. Slobody 17, 812 31 Bratislava, Slovakia

Simulations play a key role in the modern vehicle development process. They enable virtual testing of functionality, reliability, and safety of components before their physical production. Thanks to simulations, development time can be significantly shortened, prototype costs reduced, and design optimization improved. An additional advantage is the ability to test extreme operating conditions and various configurations without the risk of damaging real components. Simulation tools thus enhance the quality and innovation of the final product. The FMI (Functional Mock-up Interface) standard represents an open format for the exchange and integration of models between different simulation tools. It allows the export of models defined as FMUs (Functional Mock-up Units), which can be used for co-simulation in other software without the need to share source code. FMI supports modularity and reusability of models. [1]

The virtual model of the Kyburz eRod vehicle [2], created in Adams/Car, was used as the core component of the FMU unit.



The FMU includes not only the MBD model itself, but also a preconfigured driving maneuver, a road, and a simple control system that facilitates the exchange of information to and from the FMU. Functionality verification was performed using Matlab/Simulink, which was also chosen as the primary software tool for subsequent co-simulations. The methodology for integrating the Kyburz eRod vehicle using the FMI standard, as described in the article, is designed to be general and can also be applied to other vehicles created in Adams/Car, provided they are connected to the control system outlined in the article.

This research was supported by the Slovak Research and Development Agency under Contracts No. APVV-23-0650, APVV-20-0428, APVV-19-0401, SK-SRB-23-0024

### REFERENCES

- [1] Authorship or Source " Functional Mock-up Interface", [online] Available at: <https://fmi-standard.org/> [Accessed: date (22.5.2025)].
- [2] Authorship or Source " eRod - the electric sportscar made in Switzerland | KYBURZ", [online] Available at: <https://kyburz-switzerland.ch/en/erod> [Accessed: date (22.5.2025)].
- [3] Magdolen, Ľ., Danko, J., Milesich, T., Kevický, I., Galinský, M., BUCHA, J., SKYRČÁK, R. Virtual simulation of overtaking maneuver of autonomous vehicle. In *Strojnícky časopis = Journal of Mechanical engineering*. Vol. 71, Iss. 2 (2021), s. 179 - 188. ISSN 0039-2472

## USE OF ARTIFICIAL INTELLIGENCE IN INSPECTION CALCULATIONS OF MACHINE COMPONENTS

CÉZOVÁ Eliška<sup>1</sup>,

<sup>1</sup> Faculty of Mechanical Engineering, Czech Technical University in Prague, Department of Designing and Machine Components, Technická 4, 166 07 Prague 6, Czech Republic

This article examines the growing role of artificial intelligence (AI) in the design and verification calculations of mechanical components. The evolution from traditional manual drafting and hand calculations to computer-aided design (CAD) and now to AI-assisted engineering represents a major shift in mechanical engineering workflows. While AI has already demonstrated its usefulness in fields such as mathematical analysis and statistics, its implementation in the verification of machine elements is still developing.

Unlike pure mathematical disciplines, where AI can rely on a well-defined system of axioms and rules, mechanical component design requires a deeper understanding of physical behavior, boundary conditions, and material properties—areas where AI has historically struggled. However, recent advances in machine learning, neural networks, and data modeling have significantly improved AI's ability to process and interpret complex mechanical problems. AI can now assist in strength assessments, stress analysis, and optimization tasks, delivering results that are increasingly accurate and applicable in real engineering contexts.

This paper also discusses the educational implications of using AI as a learning aid. Engineering students often turn to AI tools such as ChatGPT or code-based systems for support when tackling complex calculations or conceptual problems. While these tools can be valuable in reinforcing learning, they also pose a risk of reinforcing incorrect methodologies or oversimplifying complex engineering logic, especially when used without critical understanding.

How artificial intelligence can be trained to calculate bearings is described in [1] and [2]. Although challenges remain—particularly regarding the generalization of AI models and their integration into professional engineering standards—the future of AI in mechanical design is promising. With proper development and supervision, AI may become a standard component of engineering practice, enhancing both accuracy and efficiency in design processes.

### REFERENCES

- [1] CÉZOVÁ, E. (2025): "Demonstration of Neural Network in Prediction of Bearing Lifetime". *Manufacturing Technology*. 25(2):170-173, DOI: 10.21062/mft.2025.017
- [2] ONDRUŠKA, J., BÁBICS, L., BOŠANSKÝ, J., PROTASOV, R. (2024). „Development hybrid high-speed electro pneumatic spindles drive unit”. pp. 49-56. In *Strojnický časopis = Journal of Mechanical engineering*. Vol. 74, no. 2 (2024), ISSN 0039-2472

# LIGHTWEIGHT COMPOSITE BUS STRUCTURES AND HYBRID HYDROGEN-ELECTRIC DRIVETRAINS FOR URBAN MOBILITY

ČULÍK Ján<sup>1</sup>

<sup>1</sup>*Faculty of Mechanical Engineering, Slovak University of Technology in Bratislava, Nám. Slobody 17, 812 31 Bratislava, Slovakia*

This work presents the design and engineering of a new generation of lightweight, modular zero-emission buses developed by Mobility & Innovation Production s.r.o. The vehicle body features a self-supporting monocoque construction fabricated from glass fiber-reinforced polymer (GFRP) composites using vacuum-assisted resin transfer molding (RTM). The sandwich structure, consisting of quadraxial glass fiber laminates in a vinylester matrix and AIREX T90.60 polymer foam core, results in a lightweight yet rigid structure with high energy absorption and corrosion resistance.



Fig. 1 Modular composite structure and monocoque bus design.

Weight optimization (~6420 kg for an 8-meter bus) improves range and efficiency. Structural performance testing demonstrated quasi-isotropic behavior with compliance to ECE R66 standards through integrated reinforcement zones. Modular architecture allows reconfiguration for various urban or intercity applications without structural compromise.

Two propulsion variants were developed: a full-electric system powered by lithium-ion battery packs (up to 180 kWh, 700 V DC) and a 160 kW Siemens PEM motor; and a hydrogen-electric hybrid using a 30 kW Loop Energy fuel cell, composite-aluminium 35 MPa hydrogen tanks, and buffer batteries. The hybrid variant achieves over 420 km range with hydrogen consumption around 3.3 kg/100 km. Efficiency was validated in operational tests, confirming 0.6 kWh/km electric and 11.0 kWh/100 km hydrogen equivalent consumption.

This project demonstrates how composite structures and hybrid energy systems can be integrated to deliver scalable, low-emission bus solutions aligned with EU climate goals (Plug Power, 2023; ICCT, 2021).

## REFERENCES

- [1] Plug Power. Fuel Cell Efficiency 101 Key Metrics, 2023. [online] Available at: <https://www.plugpower.com>
- [2] Zhao, H., Zhang, Y. Improving Thermal Efficiency of Internal Combustion Engines: Recent Progress and Remaining Challenges, 2020. [online] Available at: <https://www.sciencedirect.com/science/article/pii/S036054421931669X>
- [3] PwC. The Green Hydrogen Economy: Driving the Energy Transition, 2022. [online] Available at: <https://www.pwc.com/gx/en/industries/energy-utilities-resources/publications/green-hydrogen.html>
- [4] ICCT. Fuel-Cell Hydrogen Long Haul Trucks in Europe, 2021. [online] Available at: <https://theicct.org/publication/fuel-cell-hydrogen-long-haul-trucks-in-europe/>

## **ADVANTAGES OF COMBINING MECHANICAL ENGINEERING AND ELECTROTECHNICS KNOWLEDGE FOR THE MODERN ENGINEER**

**DAJBYCH Oldřich<sup>1</sup>, SEDLÁČEK Aleš<sup>1</sup>**

*<sup>1</sup> Czech University of Life Sciences Prague, Faculty of Engineering, Department of Mechanical Engineering, Czech Republic Kamýcká 129 165 00 Praha 6*

The engineering profession is increasingly shaped by the convergence of mechanical and electrotechnical disciplines, driven by the demand for smart, responsive, and low-cost solutions in industrial and educational environments. This paper explores the academic and practical benefits of this interdisciplinary approach. It focuses on recent trends in university curricula, lab modernisation, and the integration of programmable systems (Arduino, ESP32, Raspberry Pi) in mechanical engineering tasks. Special attention is paid to the role of programming skills in bridging traditional and digital workflows. This work supports the notion that modern mechanical engineers must possess a hybrid skillset in order to remain effective in today's design and diagnostics ecosystems. The digital transformation of industry, often framed as Industry 4.0, is redefining the competencies expected of engineers. Mechanical engineering, once largely hardware-centric, is increasingly interwoven with electronics, sensor networks, embedded systems, and software development. A clear shift is visible in academia and industrial practice, where the integration of mechanical engineering and electrotechnics is no longer optional but fundamental for solving complex problems. Recent studies have emphasised that modern mechanical engineers must understand microcontrollers, data acquisition, control systems, and basic electronics to contribute effectively to interdisciplinary teams [1, 2]. Simultaneously, programming proficiency in languages such as Python, C/C++, and microcontroller IDEs (Arduino, PlatformIO) is becoming as important as traditional CAD or simulation tools [3, 4]. In the development of custom lab tools and low-cost test devices, the synergy between mechanics and electronics is particularly apparent. Numerous studies report on embedded microcontroller systems for monitoring strain, temperature, pressure, displacement, and more [5, 6, 7]. The Department of Mechanical Engineering is using the mentioned principles to obtain cheap, customizable, and targeted measuring devices for experiments. Python programming is used for data processing from experiments and also for the automation of repeated tasks and gathering information, such as tabular data from the internet. It is getting more important to gain or train a member or members of the team with such skills. Also, students are directed to incorporate these skills into their expertise.

### **REFERENCES**

- [1] FOLTÝNEK, P.; BABIUCH, M. Measurement and data processing from IoT modules using ESP32. *Measurement and Control*, 2019, 52(6), 678–685.
- [2] SCHKODA, R.F.; SCHWEISINGER, T.A. Laboratory design and assessment. *International Journal of Mechanical Engineering Education*, 2012, 40(3), 201–213. [3] Šťastný, J. "K celkové termodynamické účinnosti tepelného motoru v kogeneračním provozu". *Energetika*, 2002, roč. 52, č. 7-8, s. 186-187, ISSN 0375-8842.
- [3] AMORIM, M. et al. Open-source test bench for engineering education. *Inventions*, 2024, 9(3), 120.
- [4] MARTIKKALA, A. et al. Trends in open-source industrial platforms. *Procedia Manufacturing*, 2021, 52, 229–234.
- [5] ABAZEED, A.; ABDELSHAKOR, M. et al. Ultra-low-cost wireless DAQ system. *Journal of Strain Analysis*, 2024.
- [6] CHILCOTT, M.; KJÆRGAARD, N. Wireless condition monitoring. *Internet of Things*, 2021, 15, 100382.
- [7] CHUAH, C.H. ESP32 rainfall gauge development. UTAR Final Year Project, 2024.

## **NEW METHODOLOGY FOR THE DEVELOPMENT OF RUBBER-METAL ELEMENTS FOR ELECTRIC DRIVE UNIT MOUNTS**

**DANKO Ján<sup>1</sup>, MILESICH Tomáš<sup>1</sup>, DOBROVOLNÝ Juraj<sup>1</sup>, BERNÁTH Martin<sup>1</sup>**

<sup>1</sup> *Institute of Automotive Engineering and Design, Faculty of Mechanical Engineering, Slovak University of Technology in Bratislava, Nám. Slobody 17, 81231 Bratislava, Slovakia*

This article presents a new methodology for improving the efficiency of the development process for rubber-metal elements in electric vehicles, specifically focusing on components used for mounting electric drive units. Traditional rubber-metal elements development methods are time-consuming and costly, often requiring extensive Finite Element Method (FEM) analyses and iterative physical testing. The core innovation is the application of reduced-order models (ROM) supported by deep learning techniques. This methodology allows for the creation of accurate and fast predictive models of RME behavior without the need for extensive FEM analyses in the initial design phases. The approach involves training neural networks using large datasets obtained from numerical simulations, enabling efficient prediction of RME response under various mechanical loads. Software tools were utilized to generate, train, and validate these reduced-order models. The results unequivocally demonstrated that this new methodology significantly reduced development time and increased the accuracy of simulations compared to conventional approaches. The article provides a substantial contribution to the automotive industry by offering practical solutions for accelerating RME development and reducing associated costs.

### **ACKNOWLEDGEMENT**

This research was supported by the Slovak Research and Development Agency under Contract No. APVV-20-0428 and APVV-23-0456.

### **REFERENCES**

- [1] AMINI, M. R., AHAMADIAN, M., & DESHPANDE, A. (2021). Vibration Analysis of Electric Vehicles: A Review. *Mechanical Systems and Signal Processing*, 146, 106982.
- [2] ZHANG, L., MENG, D., & CHEN, G. (2020). Noise, Vibrations, and Harshness of Electric and Hybrid Vehicles. SAE International.
- [3] HEIßING, B., & ERSOY, M. (2011). Chassis Handbook – Fundamentals, Driving Dynamics, Components, Mechatronics, Perspectives.
- [4] MISHRA, S. C., & KUMAR, P. (2020). Finite Element Analysis in the Design of Rubber-Metal Components for Vibration Isolation. *Engineering Analysis with Boundary Elements*, 115, 1-15.
- [5] SCHÜTZ, A., & BECHTOLD, T. (2023). Model Order Reduction of Microactuators: Theory and Application. *Actuators*, 12(235).
- [6] KULP, B. (2019). What is a Reduced Order Model and What's Its Product Development Role? ANSYS, Inc. Retrieved from: <https://www.ansys.com/blog/what-is-a-reduced-order-model-response-surface-model>.

## **THERMOGRAPHIC DETECTION OF LIVING OBJECTS USING NEURAL NETWORKS**

**DAVID Jiří<sup>1</sup>, NOVOTNÝ Vojtěch<sup>1</sup>, BROM Pavel<sup>1</sup>, ŠVEC Pavel<sup>1</sup>, BRADÁČ Josef<sup>1</sup>**

<sup>1</sup> *Škoda Auto University, Na Karmeli 1457, 293 01 Mladá Boleslav, Czech Republic*

Real-time identification of living objects is becoming an integral part of intelligent systems, particularly in the automotive industry, security applications, and rescue operations.

This article presents an analysis of current research on the use of artificial intelligence (AI), specifically neural networks, for recognizing living objects—especially under nighttime conditions using thermal imaging cameras—as a potential technical solution for intelligent assistance systems in modern vehicles.

The research focuses on the design, training, and testing of a multilayer perceptron (MLP) model aimed at recognizing the size of various animal species based on thermographic data. The network processes input vectors composed of heat trace intensity, pixel brightness, and object size within a segmented thermogram. The output layer classifies animals into five size categories and estimates their distance.

The article also discusses the process of creating a dataset essential for developing an algorithm capable of nighttime animal detection using thermal imaging sensors. Technical specifications of the thermal camera used are outlined, including key parameters such as resolution, sensitivity, and detection performance in different lighting conditions.

The collected data was divided into two main sets—training and testing. The training set was used to teach the algorithm, while the testing set served to evaluate its accuracy. The article emphasizes the importance of correct data partitioning and introduces techniques to ensure that the results are both accurate and relevant. Experimental results demonstrate that even basic neural network architectures can achieve high identification accuracy (up to 92.4%), particularly at distances of up to five meters. A practical demonstration of data processing is supplemented by visualization of thermograms and a demonstration of the network architecture.

Finally, the article outlines directions for future development, including the application of advanced convolutional and 3D neural networks, sensor fusion, and edge computing. It offers a comprehensive overview of the potential of AI for detecting living objects, with attention to both theoretical foundations and practical applications.

This research was conducted at Škoda Auto University as part of the project Application of Innovative Trends in the Automotive Sector, IGA/2024/01 Bradáč, supported by funding for the long-term conceptual development of a research organization provided by the Ministry of Education, Youth and Sports.

### **REFERENCES**

- [1] Bhadoriya, A. S., Vegamoor, V., Rathinam, S. Vehicle Detection and Tracking Using Thermal Cameras in Adverse Visibility Conditions. *Sensors*. 22(12), pp. 25, 2022. <https://doi.org/10.3390/s22124567>
- [2] Yoneda, K., Suganuma, N., Yanase, R., Aldibaja, M. Automated driving recognition technologies for adverse weather conditions. *IATSS Research*. 43(4), pp. 253-262, 2019. <https://doi.org/10.1016/j.iatssr.2019.11.005>
- [3] Kocić, J., Jovičić, N., Drndarević, V. An End-to-End Deep Neural Network for Autonomous Driving Designed for Embedded Automotive Platforms. *Sensors*. 19(9), 2019. <https://doi.org/10.3390/s19092064>
- [4] VOLNÁ, E., KOTYRBA, M., JANOŠEK, M., KOCIÁN, V. *Umělá inteligence - Rozpoznávání vzorů v dynamických datech*. 1<sup>st</sup> ed., BEN - technická literatura, Praha, 2014. ISBN 978-80-7300-497-2.

## **IMPACT OF THE INPUT DATASET SIZE ON ACCURACY OF REDUCED ORDER MODELS OF RUBBER-METAL ELEMENTS**

**DOBROVOLNÝ Juraj<sup>1</sup>, DANKO Ján<sup>1</sup>, MAGDOLEN Ľuboš<sup>1</sup>**

<sup>1</sup> Faculty of Mechanical Engineering, Slovak University of Technology in Bratislava, Institute of Automotive Engineering and Design, Nám. Slobody 17,812 31 Bratislava, Slovakia, e-mail: juraj.dobrovolny@stuba.sk

In the modern electric vehicles, increasing emphasis is placed on enhancing the overall ride comfort. This can be achieved by minimizing noise and vibrations produced during vehicle operation. [1] In comparison to internal combustion engines used in conventional vehicles, electric motors generate noise and vibrations with different frequency characteristics. These differences must be taken into account when developing rubber-metal elements (RME) for mounting the electric drivetrain. [2] Also, in the modern automotive industry, there is a constant demand to reduce the costs and enhance the efficiency of the development process, which can be achieved through various approaches. One of the possible approaches is to speed up the development process. The traditional development of RME, which relies heavily on finite element method (FEM) simulations to evaluate their static and dynamic behavior, is significantly time-consuming. [3] To make the process faster, more cost-effective, and efficient, reduced order model (ROM) simulations are utilized as an alternative. [4] For the generation of ROM, a neural network is used. Neural network needs for the generation of ROM an input dataset. The input dataset in this paper is acquired by simulating variety of RME models with various shapes and same material properties and boundary conditions with the use of the finite element method. [2,3] This paper describes the process of the input dataset generation and subsequently examines the impact of the size of the input dataset on accuracy of generated ROM and also proposes an optimal size of the input dataset for achieving sufficient accuracy. This generated input dataset serves for training and validating the neural network, after which it is able to generate ROM of RME and thus predict the static characteristics of RME, which include the dependency of static stiffness on displacement of the inner ring of the RME with the given shape and the unchanging material and boundary conditions.

### **ACKNOWLEDGEMENT**

This research was supported by the Slovak Research and Development Agency under Contract No. APVV-23-0456 and APVV-20-0428.

### **REFERENCES**

- [1] Heiβing, B., Ersoy, M. "Chassis Handbook – Fundamentals, Driving Dynamics, Components, Mechatronics, Perspectives". 1<sup>st</sup> edition, Springer Verlag, Berlin, Germany, 2011. ISBN 978-3-8348-0994-0
- [2] Danko, J. "Nová metodika vývoja gumo-kovových prvkov pre uloženie elektrických hnacích jednotiek s využitím redukovaných modelov s podporou neurónových sietí". Slovak University of Technology in Bratislava, Faculty of Mechanical Engineering, Institute of Automotive Engineering and Design. Habilitation thesis. [20.5.25], 2024.
- [3] Dobrovolný, J. "Návrh inovatívnej metodiky pre vývoj gumokovového prvku uloženia elektrickej hnacej sústavy". Slovak University of Technology in Bratislava, Faculty of Mechanical Engineering, Institute of Automotive Engineering and Design. Master thesis. [20.5.25], 2024.
- [4] Schilders, W. H. A., van der Vorst, H. A., Rommes, J. "Model order reduction: Theory, Research, Aspects and Applications". 1st edition, Springer Verlag, Berlin, Germany, 2008. ISBN 978-3-540-78840-9

## DESIGN OF DRIVES FOR THE CORE DRILLING RIG

DYNYBYL Vojtěch<sup>1</sup>, STARÝ František<sup>1</sup>, BRADÁČ Josef<sup>1</sup>, DAVID Jiří<sup>1</sup>, ŠVEC Pavel<sup>1</sup>

<sup>1</sup> Škoda Auto University, Department of Mechanical and Electrical Engineering, Na Karmeli 1457, 293 01 Mladá Boleslav, Czech Republic

Geological drilling rigs are interesting in the distribution of drive power between torque and speed in different parts of the drilling cycle and according the tools used. Hydraulic motors are best able to cope with such problems, where an internal combustion engine is most often used to drive the hydraulic pump. In our case, the objective was to develop a purely electrically driven drilling rig, which must also be disassembled into modules weighing up to 50 kg. Another challenge are the conditions in which the rig operates, namely increased dustiness, humidity, low and high temperatures.

Power distribution requirements for drives needs to be divided into two types of drives, namely the drilling head drive and the drilling head stroke drive.

For drilling head drive, the problem lies in the use of two different drilling bit materials depending on the material to be drilled and the chosen tool diameter. For soft deposits such as clay, a carbide core bit is used where high torque is required at slow speeds (circumferential speed from 0.3 to 0.8 m/s). In contrast, for hard materials such as concrete, a diamond core bit is used where a low torque is required at high speed (circumferential speed from 1 to 3 m/s).

For the stroke drive, the requirements for a stroke speed of 3 m/min must be met on the one hand when adding the drill pipe or extracting the tool contents. On the other hand, the feed rate when drilling with a diamond bit is two orders of magnitude lower in extreme cases is zero. This drive also generates tool pressure that varies depending on the tool used and the number of drill pipes used. With certain weight of drill pipes, the tool is relieved (the force is exerted against the outward direction of the borehole).

During the design of the drives, asynchronous electric motors were chosen first. For the vertical head drive, this motor was rejected due to the requirement for very slow rotational speed during the drilling process. In order to better utilize the power of the drilling head drives, two speed asynchronous motors were chosen and the weight of the motor was considered as a limiting factor. Due to the complexity of detaching the motor from the gearbox, these motors were later discarded.

Dana Industrial drives [1] used in vehicles have been designed as another type of drive to drive the drilling heads. The advantage is the compact shape of the motors and the high performance with low weight. The disadvantage is the larger diameter of the motors, which increases the minimum drilling distance from the wall. Due to the high cost, uncertainty of ease of control and integration into the rest of the rig, these motors were discarded.

As a final option, permanent-magnet synchronous motors were chosen, where the weight with gearbox and the ability to cool down during a defined cycle were considered as limiting factors. These motors are compact and in addition, operating parameters such as drill bit torque, speed and feed rate can be recorded from them.

### REFERENCES

[1] Dana Incorporated "Dana INDUSTRIAL", [online] Available at: <https://www.dana-industrial.com> [Accessed: 02-04-2025].

# AUTOMATION OF GEAR MESH STIFFNESS MEASUREMENT USING OPEN-SOURCE TECHNOLOGIES

FLEK Jan<sup>1</sup>, KARAS Tomáš<sup>1</sup>, KADEŘÁBEK Petr<sup>1</sup>

<sup>1</sup> Faculty of Mechanical Engineering, Czech Technical University in Prague, Department of Designing and Machine Components, Technická 4, 160 00 Praha 6, Czech Republic

This contribution presents an automated system for gear mesh stiffness measurement, designed to overcome limitations of traditional methods. The developed solution employs an open-source approach, utilizing precise encoder reading and control, integrated with a user-friendly graphical interface (GUI) (Fig. 1).



Fig. 1 GUI - control system of the test rig

This system aims to improve measurement accuracy, efficiency, and repeatability while reducing costs. Traditional gear mesh stiffness measurement often involves complex setups and manual processing, leading to time-consuming procedures and potential inaccuracies [1, 2].

The system utilizes an encoder for accurate angular displacement measurement, a stepper motor for controlled torque application, and a microcontroller for system control [3, 4]. A custom GUI facilitates experiment management. The test rig was redesigned to enhance measurement accuracy. The methodology involves applying controlled torque and measuring the resulting angular displacement to calculate stiffness.

Pilot measurements validate the system's performance, demonstrating improved efficiency and data consistency compared to traditional methods. The use of open-source components ensures cost-effectiveness and replicability. This automated system provides a valuable tool for more efficient and reliable gear design and analysis.

## REFERENCES

- [1] KARPAT, Fatih; YUCE, Celalettin; DOĞAN, Oğuz. Experimental measurement and numerical validation of single tooth stiffness for involute spur gears. *Measurement*. 2020, vol. 150, s. 107043. issn 0263-2241. Dostupné z doi: <https://doi.org/10.1016/j.measurement.2019.107043>
- [2] RAGHUWANSHI, Naresh K.; PAREY, Anand. Mesh stiffness measurement of cracked spur gear by photoelasticity technique. *Measurement*. 2015, vol. 73, s. 208–220. issn 0263-2241. Dostupné z doi: 10.1016/j.measurement.2015.05.022
- [3] RAGHUWANSHI, Naresh K.; PAREY, Anand. Experimental measurement of mesh stiffness by laser displacement sensor technique. *Measurement*. 2018, vol. 128, s. 63–70. issn 0263-2241. Dostupné z doi: 10.1016/j.measurement.2018.06.035.
- [4] PAVELKA, Jiří; JAVŮREK, Jiří; ČEŘOVSKÝ, Zdeněk. *Elektrické pohony*. České vysoké učení technické v Praze, 2001. isbn 9788001023143. Dostupné také z: <https://kniobot.cz/g/564436>.

## **BIOSYSTEMS ENGINEERING AND ITS INTERACTIONS WITH THE FUNDAMENTAL PRINCIPLES OF MECHANICAL ENGINEERING**

**HERAK David<sup>1</sup>, DAJBYCH Oldrich<sup>1</sup>, KABUTEY Abraham<sup>1</sup>**

<sup>1</sup> *Department of Mechanical Engineering, Faculty of Engineering, Czech University of Life Sciences Prague, Kamycka 129, 165 00, Prague, Czech Republic*

The manuscript focuses on Biosystems Engineering and its integration with the fundamental principles of Mechanical Engineering, highlighting its interdisciplinary nature. Biosystems Engineering is a field that merges engineering design and analysis with applied biological and environmental sciences. It reflects the evolution of traditional engineering disciplines toward applications involving living organisms, excluding biomedical contexts, intending to address complex biological challenges through engineering solutions. The discipline is grounded in classical mechanical principles such as Hooke's Law, Bernoulli's Equation, or widely accepted models developed by Kelvin, Newton and others, which are used to characterise and analyse the behaviour of biological materials. These materials are typically non-homogeneous and anisotropic, necessitating specialised modelling and experimental approaches. As such, statistical analysis is an essential component due to biological systems' inherent variability and complex mechanical behaviour.

A key aspect of applying biosystems engineering effectively lies in accurately evaluating and interpreting results, considering the physical, mechanical and chemical properties of the materials studied. Thus, the discipline serves as a bridge between biological understanding and engineering methods, enabling sustainable and efficient solutions in agriculture, environmental management, and related sectors.

Nowadays, the tools of Biosystems Engineering enable engineers to apply numerical methods such as the Finite Element Method (FEM), which was traditionally used exclusively for conventional engineering materials like steel, to the analysis of biological materials. Our virtual modelling systems can simulate entire processes that involve interactions between traditional and biological materials. Thanks to the Biosystems Engineering approaches, for instance, in fruit processing technology, it is now possible to design and optimise the entire system in a virtual environment to maximise juice yield and maintain high quality, all before physical implementation. These simulation tools have become integral to the broader suite of digital technologies increasingly employed across biosystems and agricultural engineering.

### REFERENCES

- [1] Holden, N. M., Wolfe, M. L., Ogejo, J. A., Cummins, E. J. (Eds.). Introduction to Biosystems Engineering. Cover design by Robert Browder. Modular undergraduate text covering energy, sensors, machinery, environmental, plant/animal, and processing systems. 1st ed. Blacksburg, VA and St. Joseph, MI: American Society of Agricultural and Biological Engineers & Virginia Tech Publishing, 2021. 570 pp. Open-access with CC BY 4.0 license. ISBN 978-1-949373-93-6 (print); 978-1-949373-97-4 (PDF).
- [2] Vallero, D. A. Environmental Biotechnology: A Biosystems Approach. — 2nd ed. Amsterdam & Boston: Academic Press, 2015. 746 pp. Comprehensive review of environmental biotechnologies, including system analysis, risk, and life-cycle assessment. ISBN 978-0-12-407776-8.
- [3] Voit, E. O. Biochemical Systems Theory: A review. *Journal of Theoretical Biology*, 2000, 206, 3 (243–272).
- [4] Helleckes, L. M., Wewetzer, S. J., Büchs, J. Machine Learning in Bioprocess Development: From Promise to Practice. *Trends in Biotechnology*, 2022, 40, 6 (647–659).
- [5] Chakraborty, S. (Designing Biological Circuits: From Principles to Applications). In *Proceedings of the International Conference on Systems and Synthetic Biology*. Boston: ICSSB Press, 2021. pp. 101–118.

# PARAMETRIC DESIGN OF THE STRUCTURAL ELEMENTS OF THE SPINDLE

HOŠTÁK Peter<sup>1</sup>, ŠOOŠ Ľubomír<sup>1</sup>

<sup>1</sup>Faculty of Mechanical Engineering, Slovak University of Technology in Bratislava, Nám. Slobody 17, 812 31 Bratislava, Slovakia

Article deals with the development of a simple application that allows to generate a functional model of the machine tool spindle and its structural parts. Parametric modelling plays a key role in the design of these models. Parameters allow these parts to be created and worked with flexibly as they directly define the dimensions, geometry and relationships between the components.

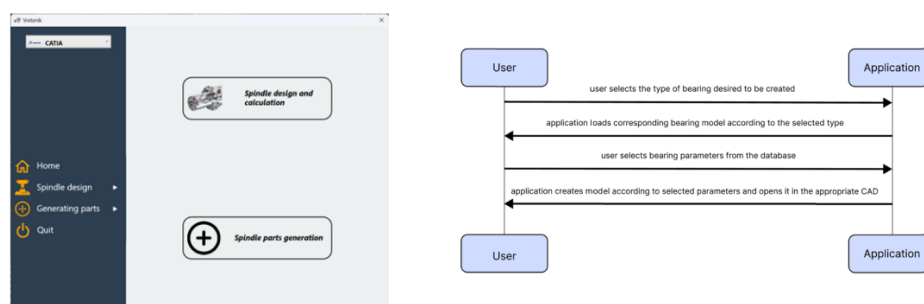

Figure 1 Application UI (left figure),  
Sequential diagram - creating a model of the selected bearing type (right figure)

The application is divided into two main modules. The first is a module for designing and creating machine tool spindles. This module will allow engineers to quickly and efficiently generate spindle models including all the necessary components.

The second module focuses only on generating bearings and other components and integrating them into the overall machine design. The second module focuses only on generating bearings and other components and integrating them into the overall machine design. In this way, the application supports a comprehensive approach to machine design and ensures that all components are designed with technical norms and standards in mind. The application represents a significant step forward in spindle design, as designers will be able to work directly with the functional model in CATIA software.

## Acknowledgements

This article was published thanks to the support of the Agency for Science and Research for the project APVV-23-00619 "Research of progressive technology of decomposition of glued layered materials"

## REFERENCES

- [1] QIBR BEARINGS, „What is the difference between face-to-face and back-to-back arrangements of angular contact bearings? “ [online] Available at: <https://www.qibr.com/news/industry-news/what-is-the-difference-between-face-to-face-and-back-to-back-arrangements-of-angular-contact-bearings>
- [2] BUČKO, B., FANDÁKOVÁ, M., ZÁBOVSKÁ, K.: 3D CAD softvérové aplikácie v procese digitálneho návrhu prototypov, [online], 2019., Available at: <https://ikaros.cz/3d-cad-softverove-aplikacie-v-procese-digitalneho-navrhu-prototypov>
- [3] Marek, Jiří. (2014). „Konstrukce CNC obráběcích strojů III“, 3. vydanie, Praha, 2014. ISBN 978 – 80 -260 – 6780 – 1
- [4] Marek, Jiří. (2023) „Stavba a provoz CNC obráběcích strojů“, 1. vydanie, Praha, 2023. ISBN 978 – 80 – 907452-3-0

## EFFECT OF HIGH-ENERGY SYNGAS COMBUSTION UNDER CONSTANT CO<sub>2</sub> AND N<sub>2</sub> CONDITIONS

CHRÍBIK Andrej<sup>1</sup>, LUKNÁR Lukáš<sup>1</sup>

<sup>1</sup> Faculty of Mechanical Engineering, Slovak University of Technology in Bratislava, Institute of Automotive Engineering and Design, Námetie Slobody 17, 812 31 Bratislava, Slovakia

In the context of growing pressure to reduce landfilled waste and diversify energy sources, synthesis gases (syngas) derived from municipal and plastic waste present a viable energy alternative. This study investigates the impact of five high-energy syngas mixtures—each with a constant proportion of inert gases (10% CO<sub>2</sub> and 5% N<sub>2</sub>)—on the combustion behavior of a spark-ignition internal combustion engine designed for use in a cogeneration unit. The key parameters analyzed include in-cylinder pressure, indicated mean effective pressure (IMEP), heat release rate, and combustion duration. Results show that an increased proportion of hydrogen in the fuel mixture leads to faster combustion, as indicated by a reduced burn duration ( $\alpha$ 10–90MFB). However, hydrogen content did not directly increase the peak in-cylinder pressure. Notably, the highest peak pressure was achieved by a mixture with moderate hydrogen and high carbon monoxide content. Conversely, a hydrogen-rich mixture exhibited the shortest burn duration but resulted in the lowest maximum pressure, primarily due to early spark timing (SOI) near the top dead center (TDC). The methane content in the fuel mixtures had a direct influence on the volumetric lower heating value (LHV), which subsequently affected both the IMEP and torque output. Compared to methane operation, the engine torque output decreased by 6% to 13.4%, and hourly fuel consumption increased from 1.56 kg/h to up to 3.87 kg/h depending on the mixture[1]. The engine stability varied with fuel composition. One of the syngas mixtures showed significant IMEP variability, indicating erratic combustion and potential operational instability. Despite having the lowest average IMEP, it delivered the third-highest torque output, albeit with the highest coefficient of variation. The comparative analysis also suggests that a higher CO-to-methane ratio promotes faster combustion and elevated peak pressures but may slightly reduce performance metrics like IMEP. In conclusion, waste-derived syngas can be a practical alternative to fossil fuels in stationary power applications, offering comparable combustion characteristics to methane when properly optimized. However, lower volumetric LHVs generally lead to reduced engine performance and increased fuel consumption. The key findings include: hydrogen reduces burn duration but also lowers the maximum pressure rise rate, peak pressure is more sensitive to ignition timing than to hydrogen content alone, methane content correlates with higher energy density and engine output, increased inert gas content and low air-fuel ratios result in higher fuel consumption. Combustion stability depends on the mixture composition, requiring careful syngas optimization. This work highlights the potential of syngas as a sustainable energy source, with implications for waste management, energy recovery, and decentralized power generation, [2].

### ACKNOWLEDGEMENT

This research was supported by the Slovak Research and Development Agency under Contract No. APVV-23-0456, APVV-20-0046, and was also supported by the Scientific Grant Agency under Contract No. VEGA 1/0666/24.

### REFERENCES

- [1] Chribik A., Poloni M., Majkut A., Gulan L., Ecsi L. High-Energy Synthesis Gases from Waste as Energy Source for Internal Combustion Engine. Sustainability. 2023, doi: 10.3390/su15107806
- [2] Brown E., MacDonald A., Allen S., Allen D. The potential for a plastic recycling facility to release microplastic pollution and possible filtration remediation effectiveness. Journal of Hazardous Materials Advances. 2023, doi: 10.1016/j.hazadv.2023.100309

## NUMERICAL ANALYSIS OF CONTACT OF CONICAL PIPES

JANČO Roland<sup>1</sup>

<sup>1</sup> Slovak University of Technology in Bratislava, Faculty of Mechanical Engineering, Institute of Applied Mechanics and Mechatronics, Nám. slobody 17,812 31 Bratislava, Slovakia, e – mail: roland.janco@stuba.sk

In practice, conical pipe connections are also found, for example, in the telecommunication mast shown in Fig. 1.

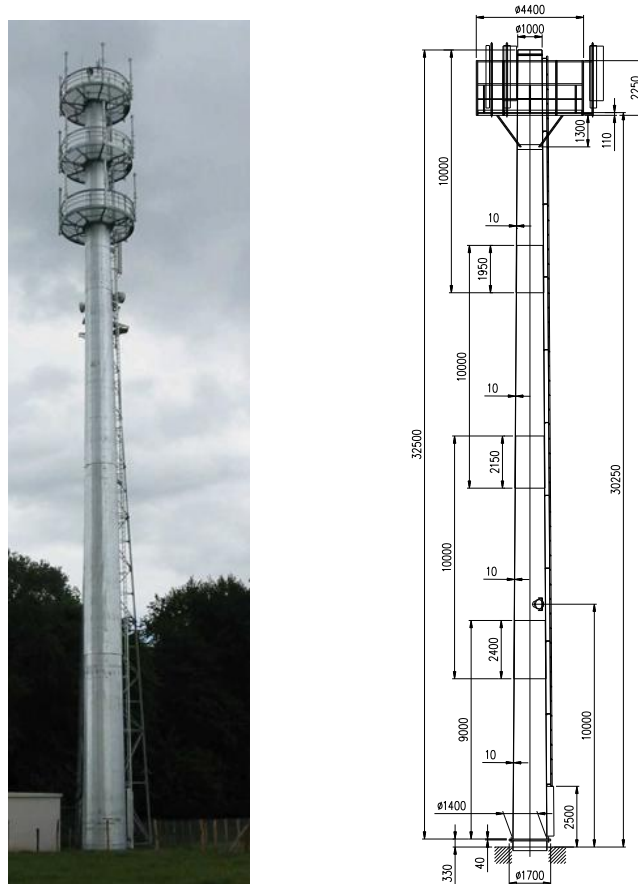

Fig. 1 Analysed telecommunication mast

The aim of this article is to present a theoretical solution for the contact of two conical pipes, considering axial force due to their self-weight, bending moment, and the influence of temperature [1, 3, 4]. We'll compare the results of this theoretical solution with a finite element model using shell elements [2]. This comparison will be performed on a longitudinal section at the contact point, as well as at selected locations perpendicular to the axis of the joined pipes

### REFERENCES

- [1] S. Timoshenko, "Strength of Materials, Part II: Advanced Theory and Problems", 2nd ed., D. Van Nostrand Company, Inc., 1947.
- [2] ANSYS Users Manual, ANSYS, Inc., 2023.
- [3] R. Jančo, "Stress analysis of pressing joint of two conical pipes," *Strojnícky Časopis – Journal of Mechanical Engineering*, vol. 73, no. 1, pp. 117–124, 2023, doi: 10.2478/scjme-2023-0009
- [4] R. Jančo, "Stress analysis of pressing joint of two conical pipes – Part 2," *Strojnícky Časopis – Journal of Mechanical Engineering*, vol. 74, no. 2, pp. 43–48, 2024, doi: 10.2478/scjme-2024-24

## DYNAMIC ANALYSIS OF PASSENGER CAR REAR-VIEW MIRRORS

JÍROVÁ Radka<sup>1</sup>, PEŠÍK Lubomír<sup>2</sup>

<sup>1</sup> Faculty of Mechanical Engineering, Technical University of Liberec, Department of the Design of Machine Elements and Mechanism, Studentská 2, 46117 Liberec, Czech Republic

<sup>2</sup> Faculty of Mechanical Engineering, Technical University of Liberec, Department of the Design of Machine Elements and Mechanism, Studentská 2, 46117 Liberec, Czech Republic

The article deals with the development of a methodology for identifying the complex dynamic behavior of a passenger car rearview mirror under operating conditions. For this purpose, modern measuring devices and simulation programs are applied. Laboratory equipment for testing components and structural units and techniques for measuring vibrations and processing results, including modal analysis and identification of operating vibration shapes, are used

In laboratory conditions, rear-view mirror vibrations were measured on a test rig with

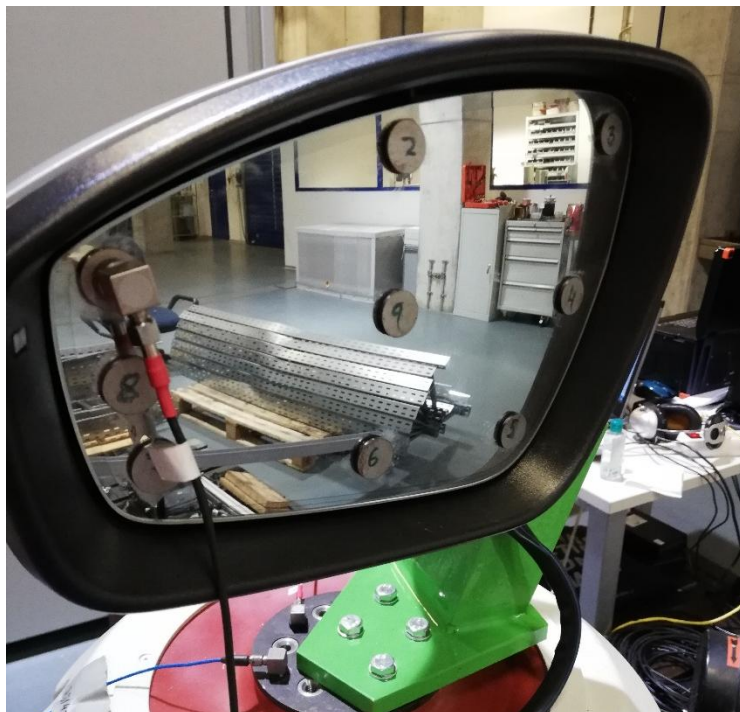

Fig. 1 Measurement of operating waveforms of rearview mirror oscillations

variable excitation modes. Operating conditions were simulated when using a broadband frequency exciter as a source of operating vibrations on a vehicle. During these tests, the rear-view mirror was mounted in a relatively rigid frame so that its operational connections to the vehicle body were respected. The main goal of vibration measurements was to determine the operating vibration shapes with defined mirror vibration amplitudes. Based on the identified critical states, design measures for minimizing vibrations were designed and laboratory-verified. In this work, computational modal analyses of 3D models of those parts of the rear-view mirror that have a fundamental influence on its dynamic behavior were also used. From the mutual correspondence

of the obtained results of the operating vibration shapes and the modal analysis of individual parts, generalized procedures for minimizing rear-view mirror vibrations were defined.

### REFERENCES

- [1] Wang, W. a kol. Vibration analysis of a coupled feed system with nonlinear kinematic joints. Mechanism and Machine Theory, Vol. 134, pp. 562-581, ISSN: 0094-114X
- [2]. Dresig H., Holzweißig F. 2008. Maschinendynamik. Berlin: Springer-Verlag. ISBN 978-3-540-87693-9..

## COMPUTATION OF FITTING FUNCTIONS FOR DESCRIBING HEMP OIL OUTPUT PARAMETERS UNDER COMPRESSION LOADING

KABUTEY Abraham<sup>1</sup>, MUSAYEV Mahmud<sup>1</sup>, KIBRET Sonia Habtamu<sup>1</sup>, SOE Su Su<sup>1</sup>,  
DAJBYCH Oldřich<sup>1</sup>, HERÁK David<sup>1</sup>

<sup>1</sup>Faculty of Engineering, Czech University of Life Sciences Prague, Department of Mechanical Engineering, Kamýcká 129, 165 00 Praha – Suchbát, Czech Republic

Compression loading is a process where bulk oilseed material of measured pressing height is loaded into a pressing vessel of known diameter with a plunger under a compression machine. The plunger is used to exert the load or pressure onto the material at a preset load value and speed. The pressing vessel has holes beneath that allow the oil to escape while the solid part is retained [1, 2]. In the literature, this process has been employed on some oilseeds such as rapeseed, sunflower and hazelnut [3–5] for extracting the oil and describing the force-deformation characteristics. This compression behaviour needs to be investigated for other oilseeds including hemp seeds which have limited available information. Hemp (*Cannabis sativa* L.) is a fibre crop growing in different climatic conditions across the world possessing high seed oil ranging between 28 and 35% depending on the varieties and climatic conditions [6, 7]. Cold pressing has been used for extracting oil from hemp seeds by a hydraulic press under different pressures. However, a considerable amount of residual oil remains in the seedcake which reduces the oil yield depending on the pressing conditions [6, 7]. The study investigated linear and polynomial functions for describing oil output parameters of bulk hemp oilseeds under compression loading. The samples of bulk hemp oilseeds were compressed at varying pressing heights from 20 mm to 100 mm using the vessel diameter of 60 mm with a plunger at a compressive load of 300 kN and pressing speed of 5 mm/min. The specific calculated oil output parameters were oil yield, deformation energy, compressive stress and hardness. The polynomial function suitably described the calculated parameters with high coefficient of determination ( $R^2$ ) values ranging from 0.735 to 0.999 in comparison with the linear function producing  $R^2$  values between 0.4 and 0.935. The study revealed that a higher compressive stress of  $63.39 \pm 0.05$  MPa is required at a lower sample's pressing height of 20 mm corresponding to a higher sample's hardness of  $14.42 \pm 0.49$  kN/mm dependent on the input speed and vessel diameter.

### REFERENCES

- [1] Herak, D., Kabutey, A., Choteborsky, R., Petru, M., Sigalingging, R. Mathematical models describing the relaxation behaviour of *Jatropha curcas* L. bulk seeds under axial compression. *Biosystems Engineering*, 2015, 131, 77-83.
- [2] Munson-McGee, S.H. D-optimal experimental designs for uniaxial expression. *Journal of Food Process Engineering*, 2014, 37(3), 248-256.
- [3] Demirel, C., Kabutey, A., Herak, D., Sedlacek, A., Mizera, C., Dajbych, O. Using Box-Behnken design coupled with response surface methodology for optimizing rapeseed oil expression parameters under heating and freezing conditions. *Processes*, 2022, 10(3), 1-18.
- [4] Gurdil, G.A.K., Kabutey, A., Selvi, K.C., Mizera, C., Herak, D., Frankova, A. Evaluation of postharvest processing hazelnut kernel oil extraction using uniaxial pressure and organic solvent. *Processes*, 2020, 8(8), 1-14.
- [5] Divisova, M., Herak, D., Kabutey, A., Sleger, V., Sigalingging, R., Svatonova, T. Deformation curve characteristics of rapeseeds and sunflower seeds under compression loading. *Scientia Agriculturae Bohemica*, 2014, 45(3), 180-186.
- [6] Kostic, et al. Optimization of hempseed oil extraction by n-hexane. *Industrial Crops and Products*, 2013, 48, 133-143.
- [7] Mathaus, B., Bruhl, L. Virgin hemp seed oil: an interesting niche product. *European Journal of Lipid Science and Technology*, 2008, 110, 655-661.

## EXPERIMENTAL ANALYSIS OF NEW TYPE OF PNEUMATIC COUPLING

KAČÍR Matúš<sup>1</sup>, GREGA Robert<sup>1</sup>, URBANSKÝ Matej<sup>1</sup>, ŽUĽOVÁ Lucia<sup>1</sup>

<sup>1</sup> Faculty of Mechanical Engineering, Technical University of Košice, Department of Engineering for Design of Machines and Transport Equipment, Letná 9, 042 00 Košice

Pneumatic flexible couplings, used for tuning of mechanical systems, used for varying their stiffness change of air volume in their flexible elements. Previously used pneumatic flexible couplings had limitations and they are no longer sufficient for certain dynamic conditions of mechanical systems [1, 2]. This article deals with testing new pneumatic flexible coupling with innovative features such as increasing twist angle of the pneumatic flexible coupling.

The pneumatic flexible chain shaft coupling (Fig.1) is designed to ensure a constant flexible transmission of torque in the system of the driving and driven machine with rotary power transmission. The valves (12) are used to fill the compression space of the coupling, formed by pneumatic-flexible elements (3), (4), (5) arranged tangentially in a chain behind each other around the circumference of the coupling, with the overpressure of the gaseous medium before the system is put into operation. The load torque from the driving body (1) to the driven body (2) of the coupling is transmitted through the compression space of the given coupling, i.e. by the pneumatic-flexible elements (3), (4), (5).

This work was supported by the following projects VEGA 1/0573/25, KEGA: 037 TUKE-04/2024 a 044TUKE-4/2024.

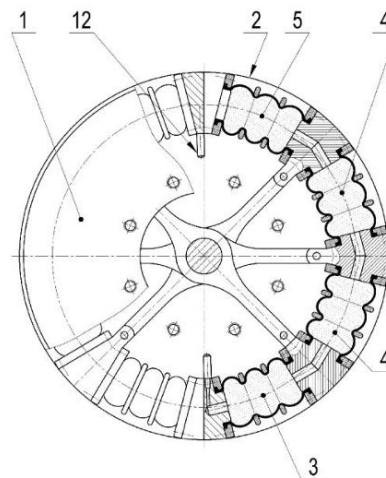

Fig. 1 Pneumatic flexible chain shaft coupling

### REFERENCES

- [1] Grega, R.; Krajnak, J.; Žuľová, L.; Kačír, M.; Kaššay, P.; Urbanský, M. Innovative Solution of Torsional Vibration Reduction by Application of Pneumatic Tuner in Shipping Piston Devices. *J. Mar. Sci. Eng.* 2023, 11, 261. <https://doi.org/10.3390/jmse11020261>
- [2] Kaššay, P., Urbanský, M., Grega, R., Krajňák, J., Kačír, M., Žuľová, L., Kulka, J. Functional prototype of pneumatic flexible shaft coupling with mechanical constant twist angle regulator. *Scientific Journal of Silesian University of Technology. Series Transport.* 2024, 125, 115-122. ISSN: 0209-3324. DOI: <https://doi.org/10.20858/sjsutst.2024.125.8>
- [3] Urbanský, M.: Pneumatická pružná reťazcová hriadeľová spojka, Spôsob prístupu: <https://wbr.indprop.gov.sk/WebRegistre/Patent/Detail/73-2017...> - Banská Bystrica : ÚPV SR - 2021. - 8 s.

## MECHANICAL BEHAVIOUR OF SLOTTED BOLTED JOINTS IN PHOTOVOLTAIC PANEL ASSEMBLIES: A FINITE ELEMENT STUDY

KANAVAL Antonín<sup>1</sup>, DIÁZ-SALAMANCA Diego<sup>2</sup>, MUÑIZ-CALVENTE Miguel<sup>2</sup>, DUB Martín<sup>1</sup>

<sup>1</sup> Faculty of Mechanical Engineering, Czech Technical University in Prague, Department of Designing and Machine Components, Technická 4, 166 07 Praha, Czech Republic

<sup>2</sup> Escuela Politécnica de Ingeniería de Gijón, Universidad de Oviedo, Dept. de Construcción e Ingeniería de Fabricación, Gijón Campus Edificio Polivalente Module 1 Ground Floor s/n 33203 Gijón, Spain

Bolted lap joints with slotted holes are commonly used in photovoltaic structures for their ease of assembly and tolerance accommodation, yet their fatigue behaviour remains insufficiently addressed in current standards such as Eurocode 3 [1]. This study investigates the quasi-static slip and fatigue performance of a double-lap bolted joint with two different slotted-hole geometries, using finite element modelling validated through a partial experimental campaign. A third, reference geometry, including circular holes instead of slotted ones, was included to benchmark the results against configurations better documented in literature and standards. Experimental slip tests and fatigue tests ( $R = 0.1$ , 15 Hz, at 95% of critical slip load) were performed on six specimens across two preload levels (66 kN and 110 kN). Results revealed that no fretting fatigue cracks occurred after 2 million cycles in any configuration. These findings correlate well with predictions using the Fatemi-Socie parameter [2], [3] which accounts for interlocking and plastic deformation effects under high pretension, unlike the more commonly used SWT parameter [4]. Contrary to reports by other authors (e.g., Jimenez-Peña et al. [5], Poovakaud et al. [6], Talemi et al. [7]) who observed fretting fatigue below theoretical slip thresholds, this study did not confirm such behaviour, suggesting that slip is the governing limit state in these cases. The work highlights that higher bolt preload increases fatigue life, particularly for some configurations, while having minimal effect on others. The findings underline the need for a more nuanced design approach to slotted-hole bolted joints, integrating computational models and probabilistic fatigue methodologies to bridge gaps in current design codes and improve the safety and efficiency of photovoltaic structural connections.

### REFERENCES

- [1] European Commission, *Eurocode 3: Design of steel structures - Part 1-9: Fatigue*. <https://eurocodes.jrc.ec.europa.eu/EN-Eurocodes/eurocode-3-design-steel-structures>, 2005.
- [2] A. Fatemi and D. F. Socie, "A CRITICAL PLANE APPROACH TO MULTIAXIAL FATIGUE DAMAGE INCLUDING OUT-OF-PHASE LOADING," *Fatigue Fract Eng Mater Struct*, vol. 11, no. 3, pp. 149–165, Mar. 1988, doi: 10.1111/j.1460-2695.1988.tb01169.x.
- [3] D. Socie, "Multiaxial Fatigue Damage Models," *J Eng Mater Technol*, vol. 109, no. 4, pp. 293–298, Oct. 1987, doi: 10.1115/1.3225980.
- [4] K. N. Smith, P. Watson, and T. H. Topper, "A Stress-Strain Function for the Fatigue of Metals," *Journal of Materials, JMLSA*, vol. 5, no. 4, pp. 767–778, Dec. 1970.
- [5] C. Jiménez-Peña, R. H. Talemi, B. Rossi, and D. Debruyne, "Investigations on the fretting fatigue failure mechanism of bolted joints in high strength steel subjected to different levels of pre-tension," *Tribol Int*, vol. 108, pp. 128–140, 2017, doi: 10.1016/j.triboint.2016.11.014.
- [6] V. Venugopal Poovakaud, C. Jiménez-Peña, R. Talemi, S. Coppeters, and D. Debruyne, "Assessment of fretting fatigue in high strength steel bolted connections with simplified Fe modelling techniques," *Tribol Int*, vol. 143, Mar. 2020, doi: 10.1016/j.triboint.2019.106083.
- [7] R. Hojjati-Talemi, M. A. Wahab, T. Yue, and L. D'alvise, "ON FRETTING FATIGUE BEHAVIOUR OF SINGLE BOLTED LAP JOINT," 2014.

## FEM ANALYZES AND EXPERIMENTAL VERIFICATION OF THE LOAD CAPACITY OF PRESTRESSED BOLTED JOINTS OF PHOTOVOLTAIC PANELS DYNAMICALLY LOADED BY WIND

MUÑIZ-CALVENTE Miguel<sup>1</sup>, DÍAZ-SALAMANCA Diego<sup>1</sup>, KANAVAL Antonín<sup>2</sup>,  
KANAVAL Jan<sup>2</sup>

<sup>1</sup> University of Oviedo, Department of Construction and Manufacturing Engineering, Gijón 33203, Spain

<sup>2</sup> Faculty of Mechanical Engineering, Czech Technical University in Prague, Dept. of Designing and Mechanical Components, Technická 4, 166 07 Prague 6, Czech Republic

Nowadays, the use of hot-dip galvanized prestressed bolted joints has greatly increased in many industrial applications, especially in the solar generation industry. The expansion of the use of these joints has occurred due to their excellent resistance to atmospheric corrosion and also because of their easy assembly and maintenance at relatively low costs. However, the fatigue behavior of these joints is still not sufficiently experimentally verified and defined in design standards, which makes their correct dimensioning difficult. This paper describes the FEM analyzes performed and the experiments carried out that evaluate different geometric configurations of joint, such as slotted and drilled holes, as well as different levels of axial preload in the bolts after assembly. The obtained results will be compared with S-N curves of similar categories of parts and joints available in current standards. This work also deals with the issue of determining the dynamic loading of these bolted joints, as well as problematic aspects in developing a structural design and implementing experimental testing of these joints.



Fig. 1 Massive Deployment of Renewable Energy.

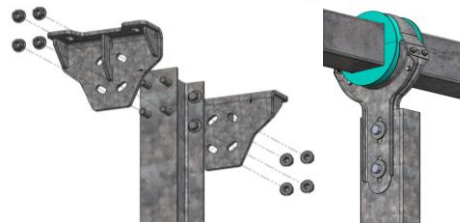

Fig. 2. Washer Joints are Used for the Assembly of these structures very Often.

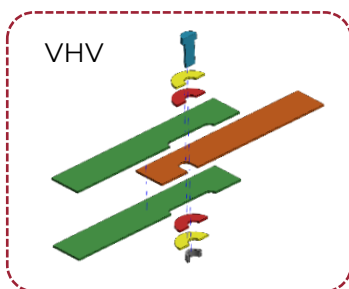

Fig. 3 Arrangement of the VHV joint test specimen.

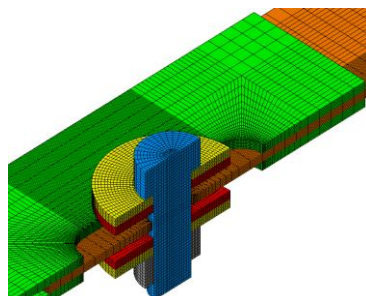

Fig. 4 FEM model of the VHV joint test specimen.



Fig. 5 Walter & Bai servohydraulic testing machine.

### REFERENCES

- [1] D. Díaz-Salamanca; A. Kanaval; M. Muñiz-Calvente; F. Pelayo; J. Kanaval. "Fatigue Performance of Hot-dip Galvanized Bolted Joints: Influence of Geometry and Preload Conditions." 41<sup>st</sup> Congress of the Spanish Fracture Group, March 26-28, Vitoria, Department of Construction and Manufacturing Engineering, Gijón 33203, University of Oviedo, Spain, 2025.

## METHODOLOGY FOR CREATING AN OVERTAKING MANEUVER IN THE SIMULINK SIMULATION ENVIRONMENT

KEVICKÝ Igor<sup>1</sup>, MAGDOLEN Ľuboš<sup>1</sup>, MILESICH Tomáš<sup>1</sup>, BERNÁTH Martin<sup>1</sup>

<sup>1</sup> Faculty of Mechanical Engineering, Slovak University of Technology in Bratislava, Institute of Automotive Engineering and Design, Nám. Slobody 17,812 31 Bratislava, Slovakia

This paper presents a detailed methodology for the design and simulation of an autonomous vehicle's overtaking maneuver within the Simulink software environment. The work focuses on developing a comprehensive system that integrates a dynamic vehicle model (encompassing kinematic and dynamic motion), advanced sensor fusion algorithms (utilizing radar and cameras), sophisticated trajectory planning, and a robust adaptive model predictive control (MPC) strategy. A primary objective is to minimize collision risk and ensure maneuver safety in a dynamic and interactive driving environment. We detail the modular architecture of the simulation, breaking it down into distinct subsystems. The functionality of each subsystem is thoroughly described, including the modeling of the surrounding environment using a Frenet coordinate system, the implementation of a Joint Probabilistic Data Association (JPDA) tracker for multi-object tracking, and the application of MPC for precise lateral and longitudinal vehicle control. The proposed system is validated within a test model featuring 360° sensor coverage, demonstrating its capability for autonomous overtaking by effectively detecting and tracking surrounding vehicles, predicting their future movements, and generating collision-free trajectories. This methodology provides a solid foundation for the development and testing of advanced autonomous driving functions.

**Keywords:** overtaking maneuver, autonomous vehicles, Simulink, sensor fusion, trajectory planning, MPC, Frenet coordinates, simulation

**Acknowledgements:** This work was supported by APVV-19-0401, APVV-23-0650 and APVV-20-0428

### REFERENCES

- [1] M. Werling, J. Ziegler, S. Kammel, and S. Thrun, "Optimal trajectory generation for dynamic street scenarios in a frenet frame," in Proceedings - IEEE International Conference on Robotics and Automation, 2010, pp. 987–993. doi: 10.1109/ROBOT.2010.5509799.
- [2] T. Gillespie, Fundamentals of Vehicle Dynamics, Revised Edition, 2nd Revised ed. SaE, 2021.
- [3] C. Burger and M. Lauer, "Cooperative Multiple Vehicle Trajectory Planning using MIQP," *IEEE Conference on Intelligent Transportation Systems, Proceedings, ITSC*, vol. 2018-November, pp. 602–607, Dec. 2018, doi: 10.1109/ITSC.2018.8569776.
- [4] J. Bhargav, J. Betz, H. Zehng, and R. Mangharam, "Deriving Spatial Policies for Overtaking Maneuvers with Autonomous Vehicles," *2022 14th International Conference on COMMunication Systems and NETWORKS, COMSNETS 2022*, pp. 859–864, 2022, doi: 10.1109/COMSNETS53615.2022.9668548.

## 3D SCANNING IN ENGINEERING APPLICATIONS

Lukas Klapetek<sup>1</sup>,

<sup>1</sup> Faculty of Mechanical Engineering, VSB Technical University of Ostrava, Department of Machine parts and Mechanisms, 17. listopadu 2172/15 708 00 Ostrava-Poruba, Czech Republic

This paper explores the use of 3D scanning in reverse engineering, particularly for mechanical parts with complex geometries. In technical practice, it is often necessary to replace old machines or specialized components that lack existing documentation, such as technical drawings or material specifications [1]. When no prior data is available, engineers have two primary approaches: they can either design a new part from scratch or employ 3D scanning to capture the precise geometry of the existing component. By utilizing advanced scanning technologies [2], engineers can efficiently generate accurate digital models, which serve as the basis for manufacturing drawings and CAD models. This method significantly reduces development time, improves accuracy, and facilitates seamless integration into production workflows. The paper focus on primarily gear scanning related with identification which has evolved significantly in the last 20 years [3] also discusses key challenges associated with 3D scanning in reverse engineering, including data processing complexity, material surface properties, and precision requirements in general. This article compares various types of scanners in terms of accuracy and uses as well.

Keywords: 3D scanning, reverse engineering, digital model, gear measurement

### REFERENCES

- [1.] VERİM, Ö.; YUMURTACI, M. Application of Reverse Engineering Approach on a Damaged Mechanical Part. *International Advanced Researches and Engineering Journal* 2020, 4, 21–28, doi:10.35860/iarej.687014.
- [2.] Zhu, S.; Gao, Y. *Non-Contact 3D Coordinates Measurement of Cross-Cutting Feature Points on the Surface of Large-Scale Workpiece Based on Machine Vision Method*; 2005;
- [3.] Shi, Z.Y.; Yu, B.; Song, H.X.; Wang, X.Y. Development of Gear Measurement Technology during Last 20 Years. *China Mechanical Engineering* 2022, 33, 1009–1024.

## COMPARISON OF NONLINEAR FINITE ELEMENT SOLUTIONS FOR SEAL COMPRESSION USING STATIC AND TRANSIENT ANALYSIS

KOZÁRIK Daniel<sup>1</sup>, SMETANKA Lukáš<sup>1</sup>, ŠTEININGER Ján<sup>2</sup>, HRČEK Slavomír<sup>1</sup>

<sup>1</sup>*Department of Design and Mechanical Elements, Faculty of Mechanical Engineering, University of Žilina, Univerzitná 8215/1, Žilina 010 26, Slovakia*

<sup>2</sup>*Institute of Competitiveness and Innovations, University of Žilina, Univerzitná 8215/1, Žilina 010 26, Slovakia*

This study presents a numerical comparison of static and transient [1, 2] structural analyses of a hyperelastic seal using ANSYS Workbench. Simulations were carried out under identical conditions, employing an Ogden [3, 4] first-order material model for EPDM rubber, frictional contacts with a pure penalty method, and a fine mesh focused on the seal with coarser mesh focused on contacting surfaces. A displacement of 1.62 mm was applied to replicate compression on a seal during assembly.

The seal was designed [5, 6] for a 6 mm wide and 5 mm deep groove, accounting for manufacturing tolerances and thermal expansion [6] between  $-40\text{ }^{\circ}\text{C}$  and  $130\text{ }^{\circ}\text{C}$ . The resulting compression ranged from 18.45% to 30.2%, with a groove filling of 89%. The geometry was adapted for 2D axisymmetric simulation to optimize computational efficiency.

Key parameters such as reaction force, stress, strain, contact pressure, contact area, and computation time were compared. Both analyses yielded nearly identical mechanical results, with differences under 1.1%. However, the transient simulation was approximately 62% faster, indicating improved solver performance for highly nonlinear contact problems.

These findings demonstrate that transient analysis can serve as a practical and efficient alternative to static simulation in quasi-static sealing applications, offering a strong balance between accuracy and computational time.

### REFERENCES

- [1] R. Naresh, V.B.S. Rajendra Prasad a G. V. Rao, *Static and Transient Response of a Leaf Spring with EPDM Rubber Sandwiched Between Steel Leaves*, Vellore: 2214-7853. <https://doi.org/10.1016/j.matpr.2020.03.286>, 2020.
- [2] Xing Zou, Chengwen Yang a B. Liu, *The Contact and Transient Dynamic Analysis of Gear Meshing with ANSYS*, Open Access Library Journal,; 7, 1-10. doi: 10.4236/oalib.1106771., 2020.
- [3] Y. Başar a M. Itskov, *Finite element formulation of the Ogden material model with application to rubber-like shells*, Int. J. Numer. Meth. Engng., 42: 1279-1305. [https://doi.org/10.1002/\(SICI\)1097-0207\(19980815\)42:7<1279::AID-NME437>3.0.CO;2-I](https://doi.org/10.1002/(SICI)1097-0207(19980815)42:7<1279::AID-NME437>3.0.CO;2-I), 1998.
- [4] B. Kim, S. Lee, J. Lee a e. al., *A comparison among Neo-Hookean model, Mooney-Rivlin model, and Ogden model for chloroprene rubber*, Int. J. Precis. Eng. Manuf. 13: 759–764 (2012). <https://doi.org/10.1007/s12541-012-0099-y>, 2012.
- [5] R. K. Flitney, *Seals and Sealing Handbook*, United Kingdom: ISBN: 978185174619, 2007.
- [6] „Applerrubber,“ 2020. [Online]. Available: <https://www.applerrubber.com/src/pdf/seal-design-guide.pdf>. [Cit. 2025].

## ANALYSIS OF THE DESIGN OF A PROTECTIVE FRAME DEVELOPED FROM CARBON COMPOSITE

KUČERA Ľuboš<sup>1</sup>, KOHÁR Róbert<sup>1</sup>

<sup>1</sup> Faculty of Mechanical Engineering, University of Žilina, department of design and machine elements,  
Univerzitná 8215/1, 010 26 Žilina, Slovakia

The geometric shapes of frames and, in general, frame structures developed from composite materials can currently be applied in countless technical applications (both industrial and societal), due to their high specific strength combined with low weight. The article deals with the design of a protective frame for a racing vehicle's superstructure and compares the mechanical properties of the frame depending on the fiber orientation and the wall thickness of the tube. It highlights significant differences in deformations for various types of carbon materials used. Figure 1 shows the frame model and its deformation when using the steel material KODUR F700 TS, which has a yield strength above 700 MPa and a tensile strength exceeding 1000 MPa, with a constant modulus of elasticity of  $E = 210$  GPa. Figure 2 shows the frame model made from composite tubes with a diameter of 38 mm and a wall thickness of 2.5 mm, using the composite material GG300 with a fiber orientation of 0-90, 0-90, 0-90, 0-90.

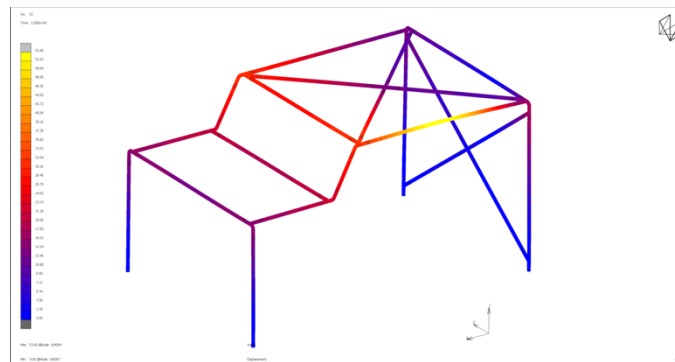

Fig.1 Deformations of the Steel Frame.

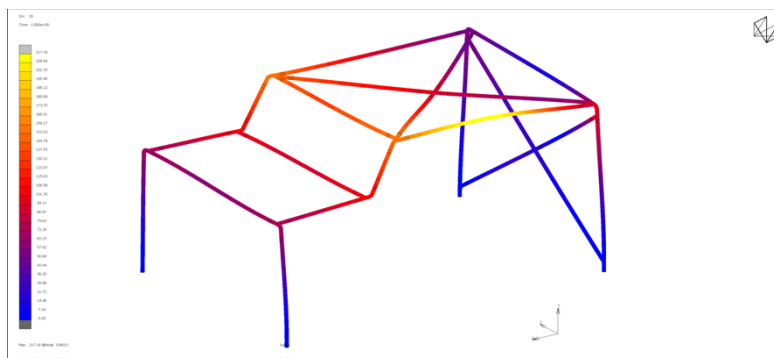

Fig 2 Deformation of the GG300 Composite frame

### REFERENCES

- [1] Jaroslav Miškolci, Analysis of the Structural Design of a Composite Protective Frame for Special Vehicles, Doctoral Dissertation, Žilina 2024

## **OPTIMIZATION OF A BIOGAS-FUEL TURBOCHARGED COMBUSTION ENGINE USED IN AGRICULTURAL EQUIPMENT**

**LUKNÁR Lukáš<sup>1</sup>, CHRÍBIK Andrej<sup>1</sup>**

<sup>1</sup> *Faculty of Mechanical Engineering, Slovak University of Technology in Bratislava, Institute of Automotive Engineering and Design, Nám. Slobody 17,812 31 Bratislava, Slovakia*

The burden of harmful emissions on the environment has increased significantly in the last two centuries. This phenomenon is mainly caused by extensive industrialization, increasing living standards and the growing number of people on the planet. These are not only indicators that reveal the current ecological deficit, but also an almost everyday problem that affects the majority of residents of cities and towns. Until now, air pollution was most pronounced in the winter months, but now, with the increase in population, it appears all year round.

Internal combustion engines have a significant impact on air quality. According to European Union statistics, in the 1990s, automobile transport significantly contributed to the deterioration of air quality, especially in connection with CO, CO<sub>2</sub> and NO<sub>x</sub> emissions.

Of the total amount of pollutants produced by various sources, transport accounted for approximately 50 to 60%. The agricultural sector is no exception, in which internal combustion engines are widely used to drive various mechanisms and machines.

Given that European institutions are increasingly striving to eliminate internal combustion engines in practice, it is necessary to find a suitable, sustainable, more environmentally friendly alternative to fossil fuels. For several years now, passenger transport and partly also freight transport have been switching to hybridization of internal combustion engines, or purely electric vehicles.

In the case of agricultural machinery, for various reasons, it is not possible to consider electrical energy as an equivalent energy source replacing fossil fuels. For this reason, the greening of the combustion process in the form of rebuilding internal combustion engines and changing the fuel used has been approached.

The research team of the Institute of Automotive Engineering and Design of the Faculty of Mechanical Engineering of the Slovak University of Technology in Bratislava focused on optimizing the turbocharged internal combustion engine ENGUL UR-II 8602.12 NG used in the Zetor 16145 tractor, which was created by modifying a diesel internal combustion engine to an engine powered by biogas. This article describes the measured performance, economic and ecological parameters of the aforementioned internal combustion engine at various loads.

### **ACKNOWLEDGEMENT**

This research was supported by the Slovak Research and Development Agency under Contract No. APVV-23-0456, APVV-20-0046, and was also supported by the Scientific Grant Agency under Contract No. VEGA 1/0666/24

### **REFERENCES**

- [1] Európsky parlament [online]. [cit. 2023-03-07]. Dostupné z <https://www.europarl.europa.eu/news/sk/headlines/society/20190313STO31218/emisie-co2-z-automobilov-fakty-a-cisla-infografika>
- [2] Štatistický úrad SR [online]. [cit. 2023-03-13]. Dostupné z [https://datacube.statistics.sk/#!/view/sk/vbd\\_sk\\_win2/zp3801rr/v\\_zp3801rr\\_00\\_00\\_00\\_sk](https://datacube.statistics.sk/#!/view/sk/vbd_sk_win2/zp3801rr/v_zp3801rr_00_00_00_sk)

## **CONTROL OF BEAM DEFLECTION MEASUREMENT BY INDUCTIVE LINEAR TRANSDUCER**

**ROMANIUK Vitalii<sup>1</sup>, NATMELAZE Nino<sup>1</sup>, MAŠČENIK Jozef<sup>1</sup>, KRENICKÝ Tibor<sup>1</sup>**

<sup>1</sup> *TUKE Fakulta výrobných technológií so sídlom v Prešove, Katedra navrhovania a monitorovania technických systémov, Bayerová 31, 08 001 Prešov*

Besides the continuous development of precision measurement technologies, the increasing requirements for the accuracy and repeatability of deformation monitoring systems have led to the focus on the verification of beam deflection measurement methods using inductive linear transducers. In order to ensure reliable data acquisition, a measuring stand was designed and assembled, where the transducer is mounted on a movable frame guided by a linear rail. This setup enables precise positioning of the sensor along the beam length and accurate capture of deflection values under varying load conditions. During the experiment, the deflection values of the beam were recorded systematically for different loading scenarios. The collected data were subsequently organized into tables for detailed analysis. The article presents the complete measurement procedure, evaluation of measurement accuracy and repeatability, as well as a discussion of the suitability of the applied measurement methodology for practical engineering applications. The influence of mechanical setup stability and transducer sensitivity on the final measurement results is also considered. The developed measurement approach allows effective verification of beam deflection under load, providing valuable insights for both educational purposes and industrial diagnostics. The findings contribute to improving the reliability of deformation monitoring in structural components, which is essential for the safe operation of mechanical systems. The measurement setup for beam deflection was developed based on planar inductive sensors, allowing precise detection of small displacements while maintaining low manufacturing cost [1]. The planar coil design ensures good linearity and compatibility with compact laboratory systems. To improve measurement accuracy, a non-contact inductive linear displacement sensor with quadrature magnetic fields was implemented, which directly relates output signal phase to displacement, providing high resolution and robust performance [2]. To minimize the impact of mechanical misalignment, a bilateral sensing configuration was adopted. This design maintains stable magnetic coupling and significantly improves measurement repeatability, achieving accuracy better than 15  $\mu\text{m}$  across the tested range [3]. Additionally, to enhance linearity and temperature stability, a noise-assisted measurement method was applied. By injecting controlled noise into the signal path, the system benefits from effective interpolation without complex computations, ensuring reliable data acquisition [4].

### **REFERENCES**

- [1] Damnjanovic, M. S., Zivanov, L. D., Nagy, L. F., Djuric, S. M., Biberdzic, B. N. "A Novel Approach to Extending the Linearity Range of Displacement Inductive Sensor." *IEEE Transactions on Magnetics*, vol. 44, no. 11, pp. 4123–4126, 2008, DOI: 10.1109/TMAG.2008.2002801.
- [2] Tang, Q., Wu, L., Chen, X., Peng, D. "An Inductive Linear Displacement Sensor Based on Planar Coils." *IEEE Sensors Journal*, vol. 18, no. 13, pp. 5256–5264, 2018, DOI: 10.1109/JSEN.2018.2839730.
- [3] Gu, X., Tang, Q., Peng, D., Weng, D. "An Inductive Linear Displacement Sensor With Bilateral Sensing Units." *IEEE Sensors Journal*, vol. 21, no. 1, pp. 296–305, 2021, DOI: 10.1109/JSEN.2020.3014674.
- [4] Kántor, Z., Polik, Z. "Noise Assisted High Performance Linear Inductive Distance Sensor." *Przegląd Elektrotechniczny*, vol. 90, no. 12, pp. 123–126, 2014, DOI: 10.12915/pe.2014.12.29.

## **EFFICIENT FUSION OF DUAL LIDAR DATA STREAMS WITH MAINTAINED ORGANIZED STRUCTURE**

**MILESICH Tomáš<sup>1</sup>, KEVICKÝ Igor<sup>1</sup>, BUCHA Jozef<sup>1</sup>**

<sup>1</sup> *Faculty of Mechanical Engineering, Slovak University of Technology in Bratislava, Institute of Automotive Engineering and Design, Nám. Slobody 17,812 31 Bratislava, Slovakia, e-mail: juraj.dobrovolny@stuba.sk*

This paper presents a method for processing and synchronizing point cloud data acquired from two LiDAR sensors mounted on a vehicle, with the goal of creating a dense, organized, and machine-learning-compatible dataset. As autonomous vehicles and advanced driver assistance systems (ADAS) become more prevalent, the quality, speed, and structure of data processing pipelines are increasingly critical. LiDAR sensors are one of the key technologies for spatial awareness and object detection, providing detailed 3D representations of the surrounding environment. However, the integration of data from multiple sensors poses several technical challenges, particularly in maintaining temporal synchronization and spatial structure suitable for downstream applications.

In this study, we utilized two identical Ouster OS1 LiDAR sensors, each providing a resolution of 32×1024 and operating at 20 Hz. The raw point clouds were collected in real traffic conditions and analyzed with a focus on identifying and compensating for time offsets between the two data streams. A synchronization algorithm was developed to align individual frames based on timestamp differences, ensuring that corresponding scenes from each sensor are accurately merged into a single, coherent point cloud.

We further focused on preserving the organized matrix structure of the point clouds, which is essential for compatibility with convolutional neural networks and other machine learning models. A 64×1024 data array was constructed by vertically stacking the frames from both sensors, while ensuring that missing data (NaN values) were handled effectively. The impact of each processing step—including raw reading, synchronization, merging, and NaN replacement—on computational performance was evaluated, highlighting the trade-off between accuracy and speed.

Our results demonstrate that with appropriate synchronization and structuring, it is possible to efficiently fuse data from multiple LiDARs into a dense, machine-learning-ready dataset. This contributes to improved perception accuracy, faster decision-making, and greater robustness in autonomous driving systems. The methods described in this work provide a foundation for further research in sensor fusion and the development of intelligent transportation technologies.

### ACKNOWLEDGEMENT

This research was supported by the Slovak Research and Development Agency under Contract No. APVV: SK-SRB-23-0024.

### REFERENCES

- [1] WEI, Y., YANG, J., GONG, C. et al. Obstacle Detection by Fusing Point Clouds and Monocular Image. *Neural Process Lett* 49, 1007–1019 (2019). <https://doi.org/10.1007>
- [2] Li, H., ZHANG, S. (2022). An Obstacles Detection Method for Sparse PointCloud Based on Hybrid Model and Multi-dimensional Segmentation. In: Zhang, Z. (eds) 2021 6th International Conference on Intelligent Transportation Engineering (ICITE 2021). ICITE 2021. Lecture Notes in Electrical Engineering, vol 901. Springer, Singapore. [https://doi.org/10.1007/978-981-19-2259-6\\_106](https://doi.org/10.1007/978-981-19-2259-6_106)
- [3] Q. Zhu, L. Chen, Q. Li, M. Li, A. Nüchter and J. Wang, "3D LIDAR point cloud based intersection recognition for autonomous driving," 2012 IEEE Intelligent Vehicles Symposium, Madrid, Spain, 2012, pp. 456-461, doi: 10.1109/IVS.2012.6232219.

## COMPUTATIONAL AND ANALYTICAL STUDIES ON HYBRID COMPOSITES REINFORCED WITH BIO-FIBERS & FILLERS

RAJESH Mishra<sup>1</sup>, VIJAY Chandan<sup>1</sup>, MULLER Miroslav<sup>1</sup>, JIRKU Petr<sup>1</sup>, KOLAR Viktor<sup>1</sup>, SHABNAM Nazari<sup>2</sup>, IVANOVA Tatiana Alexiou<sup>2</sup>

<sup>1</sup>Department of Material Science and Manufacturing Technology, Faculty of Engineering, Czech University of Life Sciences Prague, Kamycka 129, 16500 Prague, Czech Republic

<sup>2</sup>Department of Sustainable Technologies, Faculty of Tropical AgriSciences, Czech University of Life Sciences Prague, Kamycka 129, 16500 Prague, Czech Republic

The use of lightweight composite structures has several predictable impacts on the design of transport vehicles and construction materials, primarily by providing safer, faster, and eventually cheaper alternatives as compared to metal or concrete [1]. The use of lightweight materials has become more prevalent as manufacturers strive to reduce lighter weight to improve performance, to lower fuel and oil consumption, and to reduce carbon emissions.



Fig. 1 Biobased composites for automotive components

Existing approaches for reducing mass include the use of less dense materials, e.g., metal foams and composite materials, or a decrease in the material volume by reducing wall thicknesses in key structural components. In both cases, less energy is needed for transportation of the ready-made product, so that the ecologically friendly aspect of lightweight construction is supported. By using low cost, eco-friendly, and reliable materials the

environmental burden would be reduced for both the customer and the automotive industry [2]. The concept is shown in Fig. 1. These materials have been used for applications with low production volumes, because of their shortened lead times and lower investment costs relative to conventional steel fabrication. Important drivers of the growth of polymer composites have been the reduced weight and parts consolidation opportunities the material offers, as well as design flexibility, corrosion resistance, material anisotropy, and mechanical properties. Use of lightweight materials by hybridizing natural fibers and fillers with manmade materials e.g., glass, carbon or aramid is step in this direction. This approach also aligns with energy conservation regulations and policies, e.g., the European Commission with the End of Life Vehicles (ELV) European Union directive requiring vehicles to be constructed of 95% recyclable materials, with 85% recoverable through reuse or mechanical recycling and 10% through energy recovery or thermal recycling.

### REFERENCES

- [1] Chandan, V., Mishra, R.K., Kolar, V., Muller, M., Hrabe, P. Green hybrid composites partially reinforced with flax woven fabric and coconut shell waste-based micro-fillers (Elsevier, Industrial Crops and Products), 2024, 222, <https://doi.org/10.1016/j.indcrop.2024.119948>
- [2] Chandan, V., Mishra, R.K., Kolar, V., Jirku, P., Muller, M., Jamshaid, H. Numerical and Experimental Analysis of Mechanical Properties in Hybrid Epoxy–Basalt Composites Partially Reinforced with Cellulosic Fillers. (MDPI, Materials) 2023, 16, 4898. <https://doi.org/10.3390/ma16144898>

## **EFFECT OF MULTI-CYCLE CRYOGENIC TREATMENT ON THE HARDNESS OF ROLLING BEARING BALLS**

**ANTIĆ Jovana<sup>1</sup>, MIŠKOVIĆ Žarko<sup>1</sup>, PEJČIĆ Danilo<sup>1</sup>, DIX Martin<sup>2,3</sup>, PIERER Alexander<sup>2</sup>, HEIDRICH Jürgen<sup>2</sup>, MILBRANDT Matthias<sup>2</sup>**

<sup>1</sup> Faculty of Mechanical Engineering, University of Belgrade, Machine Design Department, Kraljice Marije 16, 11120, Belgrade, Serbia

<sup>2</sup> Fraunhofer Institute for Machine Tools and Forming Technology IWU, Reichenhainer Straße 88, 09126, Chemnitz, Germany

<sup>3</sup> Institute for Machine Tools and Production Processes, Chemnitz University of Technology, Reichenhainer Str. 70, 09126, Chemnitz, Germany

Ball bearings are key components in rotary mechanical systems, especially in the automotive industry, facilitating smooth rotation by reducing friction and supporting axial and radial loads. Maintaining their durability under demanding conditions requires continuous enhancement of material properties, notably hardness and wear resistance. This study examines the impact of Deep Cryogenic Treatment (DCT) on the hardness of commercially available bearing balls made from 100Cr6 (AISI 52100) steel. Unlike typical processes where DCT is applied between quenching and tempering [1, 2], this research applies a multi-cycle DCT after conventional heat treatment (Quenching–Tempering–DCT). The experimental procedure involved five cryogenic cycles on bearing balls from 6306, 6308, and 6310 deep groove ball bearings. Each cycle cooled the samples to  $-160^{\circ}\text{C}$  at  $1.5^{\circ}\text{C}/\text{min}$ , soaked for 1 hour, and reheated at the same rate to room temperature, followed by a 1-hour hold. Hardness was measured before and after treatment using the Rockwell C method (HRC) per SRPS EN ISO 6508-1:2017 standards. Results showed minimal hardness change: 6306 balls remained at 63.9 HRC; 6308 balls decreased slightly from 63.5 to 63.1 HRC ( $-0.63\%$ ), and 6310 balls increased marginally from 64.5 to 64.7 HRC ( $+0.31\%$ ). All values stayed within the required range of 58–66 HRC. These findings suggest the chosen multi-cycle DCT parameters did not significantly affect hardness, aligning with previous studies indicating limited hardness improvement when DCT follows tempering [3, 4, 5]. Although hardness was stable, residual stress measurements (not detailed here) hint at internal stress changes due to DCT. Future work aims to optimize DCT parameters to induce beneficial compressive stresses that could inhibit microcrack initiation, enhancing fatigue and corrosion resistance. This research's broader significance includes potential applications in other materials, such as those used in metal 3D printing in the automotive sector, where DCT-treated materials may achieve longer service life, greater reliability, reduced failure risk, and improved mechanical system safety.

### REFERENCES

- [1] Podgornik, B., Paulin, I., Zajec, B., Jacobson, S., Leskovšek, V. "Deep cryogenic treatment of tool steels", *Journal of Materials Processing Technology*, 229, pp. 398-406, ISSN 0924-0136, 2016,
- [2] Jovičević-Klug, P., Puš, G., Jovičević-Klug, M., Žužek, B., Podgornik, B. "Influence of heat treatment parameters on effectiveness of deep cryogenic treatment on properties of high-speed steels". *Materials Science and Engineering: A*, 829, 2022, <https://doi.org/10.1016/j.msea.2021.142157>
- [3] Idayan, A. Gnanavelbabu, A., Rajkumar, K. "Influence of Deep Cryogenic Treatment on the Mechanical Properties of AISI 440C Bearing Steel". *Procedia Engineering*, 97, pp. 1683-1691, 2014, <https://doi.org/10.1016/j.proeng.2014.12.319>
- [4] Kara, F., Çiçek, A., Demir, H. "Effect of Deep Cryogenic Treatment on Microstructure, Mechanical Properties, and Residual Stress of AISI 52100 Bearing Steel", *Engineered Science*, 2023, <https://doi.org/10.30919/es960>
- [5] Li, H., Tong, W., Cui, J., Zhang, H., Chen, L., Zuo, L. "The influence of deep cryogenic treatment on the properties of high-vanadium alloy steel". *Materials Science and Engineering: A*, 662, pp. 356-362, 2016, <https://doi.org/10.1016/j.msea.2016.03.039>

## REDUCING FUEL CONSUMPTION AND EMISSIONS WITH THE HYBRIDIZATION OF THE UDS 132 MOBILE WORK MACHINE

NAGY Miroslav<sup>1</sup>, GULAN Ladislav<sup>1</sup>, KOREC Filip<sup>1</sup>,

<sup>1</sup> Faculty of Mechanical Engineering, Slovak University of Technology in Bratislava, Institute of Automotive Engineering and Design, Námetie Slobody 17, 812 31 Bratislava, Slovakia

The paper presents the methodology of the design of a hybrid drive of a mobile work machine with an emphasis on reducing fuel consumption and emissions [1], [2]. The presented procedure was verified on the example of the UDS 132 excavator, where two variant solutions were compared: mild hybrid and full hybrid (with serial layout) [3]. On the basis of operational measurements, in which the pressure and flow curve in the hydraulic circuit of the excavator were detected, the real values of fuel consumption and CO<sub>2</sub> emissions were determined [2], [4]. The results show that the full hybrid solution delivers around 50% fuel savings, while the mild hybrid version achieves savings of 25% [1], [4]. In addition, both variants significantly reduce fluctuations in the course of power consumption, resulting in more balanced operation and more efficient management of energy flows [3]. The application of this methodology in practice allows manufacturers and users of mobile work machines to achieve significant operational and economic benefits while reducing the environmental burden [1], [5].

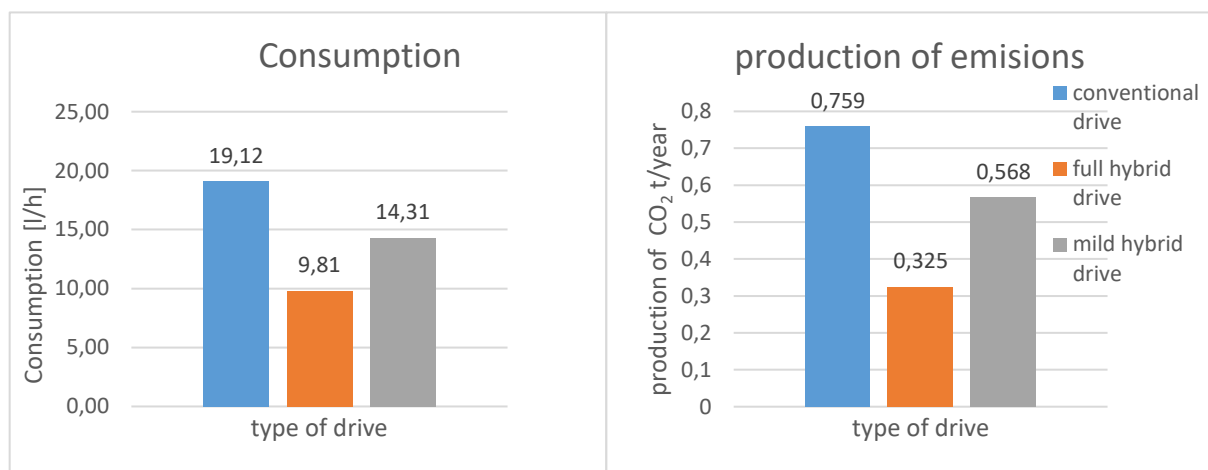

This research was supported by the Slovak Research and Development Agency under Contracts No. APVV-21-0406,

### REFERENCES

- [1] Donato, T. et al. Trends and Hybridization Factor for Heavy-Duty Working Vehicles. In: Donato, T. (ed.). Hybrid Electric Vehicles. IntechOpen, 2017. <https://doi.org/10.5772/intechopen.68296>
- [2] Giuffrida, A., Zamboni, G. Real-time estimation of fuel consumption and CO<sub>2</sub> emissions in construction machinery. Energy Procedia, 2019, 158, 4026–4031. <https://doi.org/10.1016/j.egypro.2019.01.879>
- [3] Zhang, Y., Mi, C. Vehicle Power Management: Modeling, Control and Optimization. Springer, 2011.
- [4] Lajunen, A., Lipman, T. E. Lifecycle cost assessment and carbon dioxide emissions of diesel, natural gas, hybrid electric, fuel cell hybrid and electric transit buses. Energy, 2016, 106, 329–342.
- [5] Saaty, T. L. The Analytic Hierarchy Process. New York: McGraw-Hill, 1980.

## NOTE ON CALCULATION OF SERVICE LIFE OF GEAR WHEELS ACCORDING TO ISO 6336

NĚMČEK Miloš<sup>1</sup>

<sup>1</sup> VŠB-TU Faculty of mechanical engineering, Dept. of machine parts and mechanisms, Ostrava

The ISO 6336 standard is today the basic standard in Europe for both loading capacity calculation of gears and determining their service life. This standard is relatively extensive. This makes it difficult to use easily, but it can sometimes also lead to incorrect calculation procedures [1, 2, 3]. The aim of the article is to draw attention to possible inconsistencies in calculating the service life of a gear pair. This is based on a load spectrum, which is most often defined by the so-called level load spectrum. This spectrum is given by either forces or torque moments on the pinion in relation to the number of load cycles on each level. The creation of these load spectra is demanding and takes a very long time. Furthermore, the more load levels are used, the more accurate the service life prediction is. The standard uses two hypotheses to determine the service life – Miner's and Haibach's.

It is important to recognize the differences when using both hypotheses. When comparing the results of calculations for the same load spectrum, sometimes significant differences appear. This is mainly due to the fact that it is necessary to determine the values of the factors  $K_F$ ,  $K_H$ ,  $K_{Fekv}$  and  $K_{Hekv}$ . These are also determined using both of the aforementioned hypotheses and the load spectrum. When numerically processing surface load spectra, inconsistencies often occur in the approximation in the area of the endurance limit.

It is also very important to correctly evaluate the results of calculations with loads in the area close to the strength limit. There, even with a high service life, a critical safety value for this limit may occur. Another point is the need not to use linear approximation when calculating equivalent moments (forces) and also the factors  $K_{Fekv}$  and  $K_{Hekv}$ . Here, it is imperative to apply a logarithmic approximation instead of the commonly used linear one.

It is important to note that these service life calculations cannot be performed manually, but only programmatically. And it is very important to carefully monitor the calculation process in the area of the endurance limit and also just below the strength limit.

### REFERENCES

- [1] NĚmček, M. "Comments on ISO 6336 – 6". Book of proceedings of 56th International Conference of Machine Design Departments. Pgs. 213-218. Beladice 2015. ISBN 978-80-552-1377-4.
- [2] NĚmček, M. "Remarks and corrections to the standard ISO 6336". Scientific Journal of Silesian University of Technology – series Transport. Volume 99, pages 115-124. Katowice 2018. ISSN 0209-3324
- [3] Medvecký, Š., at al. "Current Methods of Construction Design". Pgs. 127-130. Springer International Publishing, 2020. ISBN 978-3-030-33146-7.

## EVALUATION OF COOLING PARAMETERS FOR HIGH-SPEED SPINDLES WITH HYBRID DRIVE

**ONDRUŠKA Juraj<sup>1</sup>, PROTASOV Roman<sup>1</sup>, BOŠANSKÝ Miroslav<sup>1</sup>, BABICS Jozef<sup>2</sup>**

<sup>1</sup> Faculty of Mechanical Engineering, Slovak University of Technology in Bratislava, Institute of Automotive Engineering and Design, Nám. slobody 17,812 31 Bratislava, Slovakia

<sup>2</sup> Faculty of Mechanical Engineering, Slovak University of Technology in Bratislava, Institute of manufacturing systems, environmental technology and quality management, Nám. slobody 17,812 31 Bratislava, Slovakia

High-speed spindles operating at frequencies of 100,000-120,000 rpm are traditionally driven by compact BLDC (Brushless DC) motors with high efficiency. Despite their effectiveness, such motors generate significant amounts of heat requiring forced cooling. Standard solutions are based on water cooling of the stator; however, this approach has certain limitations and implementation complexities [1, 2].

The patented hybrid drive system for high-speed spindles used in cotton yarn production presents an innovative solution – a combination of series-connected pneumatic turbine and BLDC motor. One of the key design features is the utilization of exhaust compressed air from the turbine for cooling the electric motor [3].

This approach provides direct cooling of heated surfaces – the airflow directly contacts the rotor and stator surfaces.

In this work, CFD modeling of airflow patterns was performed to determine the effectiveness of pressure regulation systems in specific spindle zones - at the turbine outlet and in the rear bearing area. This enabled the acquisition of data that can be used for preliminary analytical evaluation of turbine efficiency. The importance of this data is explained by the potential reduction in turbine efficiency due to the creation of relatively high pressure at its outlet. Additionally, modeling of airflow passage between the stator and rotor was conducted using additional aerodynamic elements at the inlet, which were not considered in the original patent. This allowed for evaluation of the proposed solutions' effectiveness and determination of parameter values affecting the cooling of heated motor surfaces. Furthermore, parameters affecting rotational resistance of the rotor due to aerodynamic friction from the passing airflow were assessed.

The obtained data will enable implementation of design modifications to the patented spindle prior to conducting initial field tests on prototype samples. This will reduce the number of modifications required in test specimens and accelerate the development of an effective working solution.

The research presented in this paper is an outcome of the project VEGA No. 1/0708/24 “Research on the design parameters of the high-speed spinning spindle of the progressive concept” and the Slovak Research and Development Agency under Contract No. APVV-24-0641 “Research on hybrid electro-pneumatic spindle for high-speed machining with AI support.”

### REFERENCES

- [1] Ibrahim A. Elhawary. “Mechanics of Rotor Spinning Machines”, CRC Press: Alexandria University, Alexandria, Egypt, Pp 283. 2017. ISBN 978-1-4987-1664-2.
- [2]. Šooš, E., Ondruška, Ju., Bábics, J., Onderová, I., Bučko, E., Budický, T. “Kombinovaný elektropneumatiký pohon vretena”. Banská Bystrica, Úrad priemyselného vlastníctva SR, 9 s. 2021.
- [3] Cézová, E. „Economical and Statistical Optimization of the Maintenance in the Production Process”. pp. 32-39. In Manufacturing Technology, 23 (1) (2023), ISSN:1213-2489.

# APPLICATION OF GENERAL SPECIFICATIONS AND 3D SCAN VERIFICATION

PETR Karel<sup>1</sup>

<sup>1</sup> Faculty of Mechanical Engineering, Czech Technical University in Prague, Department of Designing and Machine Components, Technická 4, 160 00 Prague, Czech Republic

This paper investigates the verification of CAD models using advanced 3D scanning technology, emphasizing its role in assessing geometric deviations in manufactured components. The verification process (see Fig. 1) begins with the alignment of 3D scans to nominal CAD models, followed by a detailed comparison through deviation mapping and quantitative tolerance evaluations.

Furthermore, this paper explores the implementation of new geometric specifications introduced in ISO 22081, demonstrating their practical application and impact on precision engineering. Key principles of ISO 22081 are analyzed, highlighting its advantages over the now-obsolete ISO 2768-2 standard [2]. Integrating 3D scanning into verification workflows enhances reliability, enabling precise assessments of compliance with modern specifications. Ensuring dimensional accuracy in manufacturing is critical for maintaining quality and adherence to evolving industry standards.

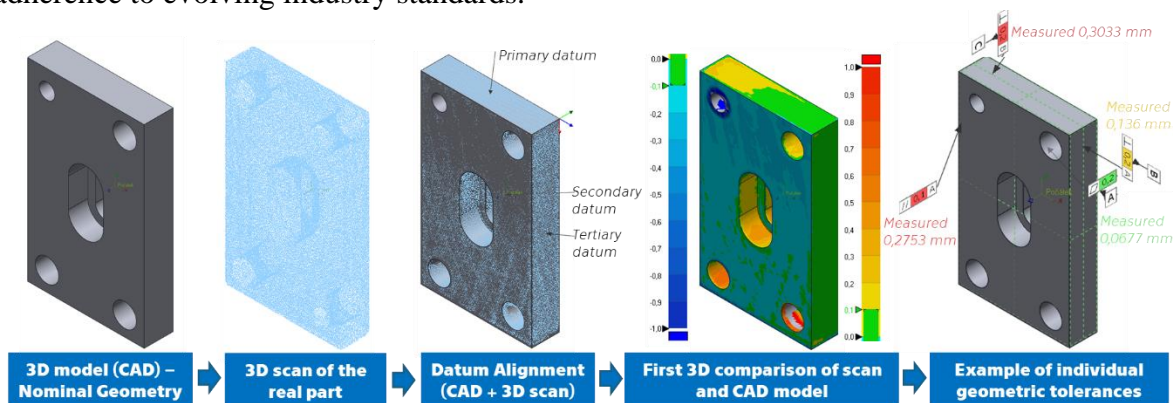

Fig. 1 Process of Verification of real part with CAD Model Using 3D Scanning.

This paper provides a comprehensive guide for professionals seeking to adopt the latest geometric standards and verification methodologies in their manufacturing processes. The refined ISO 22081 specifications offer a clearer interpretation of permissible geometric variations, ensuring greater consistency throughout various production stages [1].

Unlike traditional contact-based measurement techniques, 3D scanning enables non-invasive, highly accurate assessments of component geometries. It facilitates the efficient detection of deviations between CAD models and manufactured parts, thereby supporting improved quality control and production optimization [3].

## REFERENCES

- [1] Jozef, Bronček & Drbúl, Mário & Konstantova, Viera & Čuchor, Daniel. (2024). Interpretation of New Rules for Using of General Geometric and Dimensional Specifications in Drawings According to International Standard. [https://doi.org/10.2991/978-94-6463-423-5\\_8](https://doi.org/10.2991/978-94-6463-423-5_8).
- [2] Petr, Karel. (2024). Application and Explanation of General Geometrical Tolerances According to ISO 22081. [https://doi.org/10.2991/978-94-6463-423-5\\_7](https://doi.org/10.2991/978-94-6463-423-5_7).
- [3] Adam, Alexandru-Dragoş & Savastre, Alexandru & Dumitraş, Diana & Botiş, Răzvan-Horia. (2022). Study on the Use of 3D Scanning as a Verification Method in Technical Quality Control. *Journal of Military Technology*. 5. 35-40. <https://doi.org/10.32754/JMT.2022.1.05>.

## INVESTIGATION OF A COMBINED SYSTEM FOR AXIAL PRELOAD OF HIGH-SPEED SPINDLE BEARINGS

PROTASOV Roman<sup>1</sup>, ONDRUŠKA Juraj<sup>1</sup>, BOŠANSKÝ Miroslav<sup>1</sup>, BABICS Jozef<sup>2</sup>

<sup>1</sup> Faculty of Mechanical Engineering, Slovak University of Technology in Bratislava, Institute of Automotive Engineering and Design, Nám. slobody 17,812 31 Bratislava, Slovakia

<sup>2</sup> Faculty of Mechanical Engineering, Slovak University of Technology in Bratislava, Institute of manufacturing systems, environmental technology and quality management, Nám. slobody 17,812 31 Bratislava, Slovakia

The key operational parameters of high-speed spindles for cotton fiber yarn production are operating rotational frequencies in the range of 100 – 150 thousand rpm and power consumption of approximately 100 W. Design parameters are characterized by a minimal number of components that must have simple geometry and relatively straightforward assembly. This is attributed to mass production requirements, small component dimensions, and limited-service life. During spindle operation, significant heating of the bearings occurs along with corresponding thermal expansion of their elements, resulting in clearances between balls and raceways varying within considerable limits. In cases of excessive clearance at operating rotational frequencies, shaft vibration occurs, while absence of clearance after heating leads to even greater rotational resistance and, consequently, additional heating. This paper examines a design solution for shaft stabilization across the entire range of operating temperatures, which is proposed for implementation in an already patented spindle design with hybrid electro-pneumatic drive [1]. The proposed solution consists of the outer ring of the rear bearing as a separate component that has axial mobility relative to the housing. A wave ring spring is used to create part of the required axial force. Dynamic stabilization will be implemented using compressed air that acts on the end surface of the movable outer bearing ring in the direction of spring pressure. Air supply is accomplished through special chambers in the housing during specific operating modes – acceleration and deceleration.

This solution advantageously differs from analogs with hydraulic bearing preload in that it utilizes already available compressed air required for operating the pneumatic turbine in the hybrid spindle drive system. Among the advantages, one can note less stringent requirements for pneumatic chamber sealing, since absence of complete tightness will not reduce preload efficiency. Another positive effect is the overall simplicity of the compressed air supply control system solution. These features correspond to the concept for spindles of this class – application of cost-effective and simple solutions for mass production [2, 3].

The research presented in this paper is an outcome of the project VEGA No. 1/0708/24 “Research on the design parameters of the high-speed spinning spindle of the progressive concept” and the Slovak Research and Development Agency under Contract No. APVV-24-0641 “Research on hybrid electro-pneumatic spindle for high-speed machining with AI support.”.

### REFERENCES

- [1] Ondruška, J., Šooš, E., Babics, J., Bošanský, M., Protasov, R. "Development Hybrid High-Speed Electro Pneumatic Spindles Drive Unit". *Strojnícky časopis - Journal of Mechanical Engineering Slovak University of Technology*, 74, no. 2, pp. 49-59, 2024. DOI: 10.2478/scjme-2024-0025
- [2] Cézová, E. "Demonstration of Neural Network in Prediction of Bearing Lifetime". *Manufacturing Technology*, 25 (2) 2023, ISSN:1213-2489 DOI: 10.21062/mft.2025.017
- [3] Guilherme, L., Hui, L., Brumercik, F., Glowacz, A., Sułowicz, M., Kozik, J., Irfan, M., Piech, K., Gutten, M., & Korenciak, D., Glowacz, W., Caesarendra, W., Li, Z. Kumar, A. Fault diagnosis of electrical faults of three phase induction motors using acoustic analysis. *Bulletin of the Polish Academy of Sciences Technical Sciences*. 148440-148440. 2024, DOI: 10.24425/bpasts.2024.148440.

## COMBUSTION CHAMBER FOR HYDROGEN INTERNAL COMBUSTION ENGINES WITH DUAL INJECTION

PUŠKÁR Michal<sup>1</sup>, TARBAJOVSKÝ Pavol<sup>1</sup>

<sup>1</sup> Faculty of Mechanical Engineering, Technical University of Kosice, Letná 9, 04001 Košice, Slovakia

The current industrial policy of the European Union is defined by its ambition to achieve carbon neutrality, with particular attention given to the transport sector, which faces significant pressure to reduce emissions. The transition to alternative propulsion systems must proceed gradually, taking into account the structure of the automotive industry and its supplier networks. According to current forecasts, internal combustion engines will continue to play a key role in 2030, particularly in aviation, maritime transport, and long-distance road freight. One of the main technological challenges is the efficient combustion of hydrogen fuel, which holds significant potential for application in the next generation of internal combustion engines [1, 4]. However, a critical issue remains the control of the hydrogen combustion process, which is highly sensitive to operating conditions [2]. The proposed combustion chamber for hydrogen internal combustion engines with dual injection represents a technical solution aimed at improving the reliability and efficiency of hydrogen-powered combustion systems [3]. From a structural perspective, the combustion chamber consists of a cylinder head housing intake and exhaust valves, a high-pressure injector, and a spark plug. The cylinder head is firmly connected to the cylinder in which the piston moves, and the system also includes a low-pressure injector [3]. The piston incorporates a specially shaped compression space formed by a series of concentric rings – intake, expansion, ejector, and compression. The main advantage of this configuration lies in its ability to effectively manage the hydrogen combustion process, which is one of the key barriers to implementing this technology in mass-produced engines [2]. The system's operation is based on dual injection of the same fuel type via two independent injection systems – a high-pressure and a low-pressure injector. Both systems allow for single or multiple fuel dosing depending on the operating mode [1]. The proposed solution is compatible with standard internal combustion engine architectures and enables operation across a wide load range while significantly reducing emissions [1, 3]. The combustion chamber for hydrogen internal combustion engines with dual injection offers a promising solution that may substantially contribute to meeting emission targets in the transport sector while also enabling the efficient use of sustainable fuels [4].

### ACKNOWLEDGMENTS

This work was supported by the Slovak Research and Development Agency under the Contract No. APVV-23-0266. The article was written in the framework of Grant Projects: VEGA 1/0495/25 “Research and implementation of low-emission technologies for sustainable drive systems in transport” and KEGA 007TUKE-4/2023 “Transfer of innovations and advanced technologies, determined for more ecological and more efficient vehicle drive systems, into the educational process”.

### REFERENCES

- [1] Feng, Y., Li, Z., Chen, Y. "Experimental Study on the Impact of Hydrogen Injection Strategy on Engine Performance and Emissions." ACS Omega, 2023, roč. 8, č. 44, s. 40841–40850. ISSN 2470-1343.
- [2] Ahmadi, P., Mohammadi, A., Ghassemi, H. "Design Trends and Challenges in Hydrogen Direct Injection (H<sub>2</sub> DI) Engines." International Journal of Hydrogen Energy, 2024. ISSN 0360-3199
- [3] Bencs, P., Jóri, J., Darányi, D. "Optimization of Hydrogen Combustion in Diesel Engines." Vehicle Power and Propulsion, 2023, roč. 6, č. 2, s. 27–36. ISSN 2673-3994
- [4] Verhelst, S., Wallner, T., Van Blarigan, P. "A Comprehensive Overview of Hydrogen-Fueled Internal Combustion Engines." Energies, 2021, roč. 14, č. 20, s. 6504. ISSN 1996-1073

## **TRANSPORT PHENOMENA IN THE CATHODE TRACT OF A HYDROGEN PEM FUEL CELL**

**Rastislav Putala<sup>1</sup>, Viktor Ferencey<sup>2</sup>**

<sup>1</sup> *Institute of Power Machines and Equipment, Faculty of Mechanical Engineering, STU in Bratislava, Nám. Slobody 17,812 31 Bratislava, Slovakia*

<sup>2</sup> *Hydrogen Fuel Cells Slovakia, j.s.c. Bratislava*

This paper focuses on the complex transport processes in the cathode tract of a hydrogen PEM (Proton Exchange Membrane) fuel cell, which significantly affect the achieved values of the cell output parameters. Transport processes on the cathode side of a hydrogen PEM fuel cell are specific to different parts (sections) of the cathode tract, which includes the cathode gas flow channel denoted by the symbol GFC, the reactant-air diffusion layer (GDL) and the cathode catalytic layer (CCL). The individual parts of the cathode tract differ in their function, design and material. It is shown how the generally valid equations are affected by the physical structure of the PEM fuel cell. Since several phases coexist during the operation of the fuel cell, it is shown where interphase interactions occur. The oxygen and proton transport losses occurring in the catalyst coated layer (CCL) as well as the oxygen transport losses in the gas diffusion layer (GDL) are pointed out. The changes in temperature, relative humidity and gas pressure on the cathode side are analyzed. The paper explicitly describes the main factors that affect the quality of transport processes in individual parts of the cathode tract of a hydrogen PEM fuel cell.

**Keywords:** hydrogen fuel cell, gas transport, diffusion layer, catalytic layer, cathode, air, oxygen, nitrogen, water vapor, protons, electrons, reactants.

### **REFERENCES**

- [1] Birgersson E.: Mathematical Modelling of Transport Phenomena in Polymer Electrolyte Fuel Cells and Direct Metanol Fuel Cells. Doctoral Thesis, Royal Institute of Mechanics Stockholm, Sweden, 2004.
- [2] Kulikovskiy, A.A.: The Effect of Steichiometric Ratio  $\lambda$  on the Performance of a Polymer Electrolyte Fuel Cell. *Electrochimica Acta* 49, 617–625, 2004.
- [3] Lauze K.C., Chmielewski D.J.: Power Control of a Polymer Electrolyte Membrane Fuel Cell. *Ind. Eng. Chem. Res.*, Vol.45, No13, 4661-4670, 2006.
- [4] Spiegel C.: PEM Fuel Cell Modeling and Simulation Using MATLAB. ELSEVIER, New York, USA, 2008, ISBN 978-0-12-374759-9.

## DEVELOPMENT OF A STACK FOR VANADIUM REDOX FLOW BATTERIES

### SIGWARTH Claudia<sup>1</sup>

<sup>1</sup> *INO-HUB Energy j.s.a., Tomášikova 30, 821 01 Bratislava, Slovakia*

The energy of a Vanadium Redox Flow Battery is stored completely in the liquid electrolyte which is located in two separate tanks for negative and positive electrolyte. For charging and discharging the battery, the electrolytes must be pumped through the stack, where the electrochemical conversion takes place. A battery stack consists of several single cells that are stacked on top of each other. Each single cell, in turn, consists of two half-cells with two carbon-felt-electrodes separated by an ion-exchange-membrane. Between the single cells are graphite-bipolar-plates. The basic structure of the stack consists of polymer-frames, one for each half-cell, which are fixed by two end plates that are compressed by tie-rods.

Developing a battery stack from scratch, some basic design considerations must be done:

The first step is to fix the size of the active area of the stack, which determines its nominal power. In general, the material costs for a big stack are lower, but manufacturability, handling and space conditions inside the battery container as well as the availability of materials must be considered. Next, the thickness of the frames must be fixed. Thin frames have the advantage of low resistance due to thinner electrodes and/or higher electrode compression. Thicker frames, on the other hand, provide better flow due to less pressure drop. The length-width-ratio of the electrode-felt must be set by considering the pressure drop of the electrolyte-supply-channels and the pressure drop of the electrode-felt itself. Furthermore, the electrolyte-channels in the frames must be designed with respect to pressure drop as well as shunt currents, which are currents through the electrolyte-channels of the stack that are causing energy losses. Additionally, a suitable sealing concept must be developed. The shape, dimensions and compression must be chosen to guarantee tightness over the whole lifetime of the stack. Materials must be selected regarding costs, mechanical and chemical stability as well as electrochemical performance. For the customized parts of the stack, the optimal manufacturing process must be chosen. The goal is to have full functionality at the lowest price possible. Finally, all parts of the stack must be optimized regarding price and the handling. At transition to mass-production, the stack must be cheap and easy to assemble with high reproducibility and low scrap rates.

Having considered all these points mentioned in the section above, InoHub has successfully developed a stack for Vanadium Redox Flow Batteries. The InoHub-Stack is designed to provide the nominal power of 9 kW. At the operation at 1 bar and 35°C electrolyte temperature the stack reaches an energy efficiency of 80%.

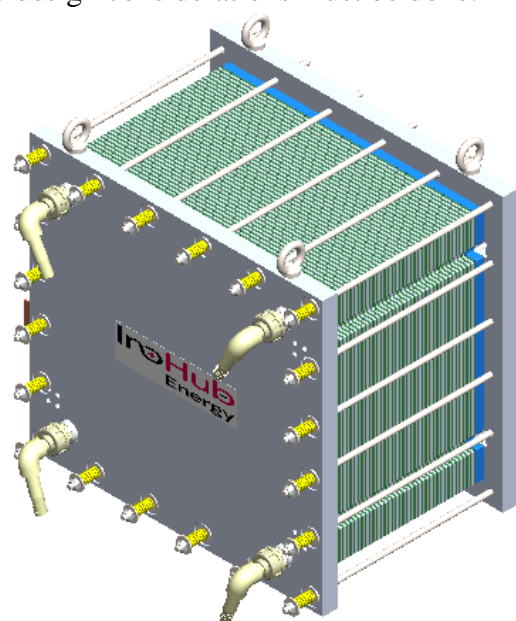

Figure 1 CAD-Model of the InoHub Battery Stack

## DESIGN OF EQUIPMENT FOR CARBON CAPTURE

SNIEHOTTA Patrik<sup>1</sup>

<sup>1</sup> VŠB – Technická univerzita Ostrava Katedra částí a mechanismů strojů 17. listopadu 2172/15, 708 00  
Ostrava-Poruba

As concerns over climate change intensify, carbon capture technologies are increasingly viewed as essential tools in reducing greenhouse gas emissions. Carbon capture and storage (CCS) involves the separation of carbon dioxide (CO<sub>2</sub>) from industrial and energy-related sources and its long-term storage. The design of equipment for carbon capture is central to the efficiency, cost-effectiveness, and scalability of CCS systems.

The first stage in CCS is the capture of CO<sub>2</sub>, which can be achieved using three primary methods: post-combustion, pre-combustion, and oxy-fuel combustion. Among these, post-combustion capture is the most widely implemented, particularly in retrofitting existing power plants [1]. This method typically employs absorption columns where flue gas passes through a solvent—commonly amine-based solutions—that chemically binds with CO<sub>2</sub>. The design considerations for absorption columns include gas-liquid contact efficiency, pressure drop, and solvent regeneration requirements [2]. Another key component is the stripping column, used to regenerate the solvent by heating, thereby releasing the absorbed CO<sub>2</sub>. The energy required for regeneration, known as the "energy penalty," is a major design and economic constraint. Engineers must optimize column dimensions, heat integration systems, and solvent properties to reduce energy consumption [3]. Membrane separation is another emerging technology for CO<sub>2</sub> capture. It involves the selective permeation of CO<sub>2</sub> through polymeric or ceramic membranes. The design challenges include achieving high selectivity and flux, maintaining mechanical stability under high pressure, and preventing membrane fouling [4].

Integration with existing plants requires additional design considerations. Piping systems, compressors, and heat exchangers must be carefully engineered to handle the captured CO<sub>2</sub> safely and efficiently. Material selection is critical to prevent corrosion and ensure long operational life. In conclusion, the design of carbon capture equipment is a multidisciplinary effort involving chemical engineering, materials science, and process integration. Future improvements are expected to focus on reducing costs, increasing energy efficiency, and enabling modular, scalable systems for a variety of industrial applications.

### REFERENCES

- [1] E. S. Rubin, J. E. Davison, and H. J. Herzog, "The cost of CO<sub>2</sub> capture and storage," *International Journal of Greenhouse Gas Control*, vol. 40, pp. 378–400, Oct. 2015, doi: 10.1016/j.ijggc.2015.05.018.
- [2] M. Bui *et al.*, "Carbon capture and storage (CCS): The way forward," May 01, 2018, *Royal Society of Chemistry*. doi: 10.1039/c7ee02342a.
- [3] D. Y. C. Leung, G. Caramanna, and M. M. Maroto-Valer, "An overview of current status of carbon dioxide capture and storage technologies," 2014, *Elsevier Ltd*. doi: 10.1016/j.rser.2014.07.093.
- [4] L. Zhao, E. Riensche, R. Menzer, L. Blum, and D. Stolten, "A parametric study of CO<sub>2</sub>/N<sub>2</sub> gas separation membrane processes for post-combustion capture," *J Memb Sci*, vol. 325, no. 1, pp. 284–294, Nov. 2008, doi: 10.1016/j.memsci.2008.07.058.

## DESIGN OF RUBBER HOSE DEFECT TESTING EQUIPMENT.

SRB Pavel<sup>1</sup>, VOSÁHLO Josef<sup>1</sup>

<sup>1</sup> Faculty of Mechanical Engineering, Technical University of Liberec, Department of Machine Parts and Mechanism, Studentská 2, 46001 Liberec, Czech Republic

Defect detection in rubber hoses is essential for ensuring the reliability of components used in the automotive industry. Currently, quality control of these hoses is often performed manually, with operators relying solely on touch to identify potential defects. This method is highly subjective and depends on the experience of the inspector, which can result in missed minor yet critical defects, such as delamination. This article presents the design and development of a simple device for semi-automated defect detection based on differences in the mechanical stiffness of the hose material. The device operates on the principle that a test roller, preloaded by a spring, is pressed against the surface of a moving hose. In areas with reduced stiffness, typically where a defect is present, the roller penetrates deeper into the rubber. The displacement of the pin is measured using a dial gauge, enabling precise quantitative evaluation of stiffness variations and thus the localization of potential defects. The proposed device serves as an experimental intermediate step for verifying the effectiveness of this detection principle. Initial testing results indicate that the method based on mechanical stiffness measurement is capable of identifying defects that would otherwise be detected only by skilled touch. In the next phase of development, the device will be enhanced with an automated drive and electronic data evaluation system, aiming toward the creation of a fully automated quality control system for rubber hoses.

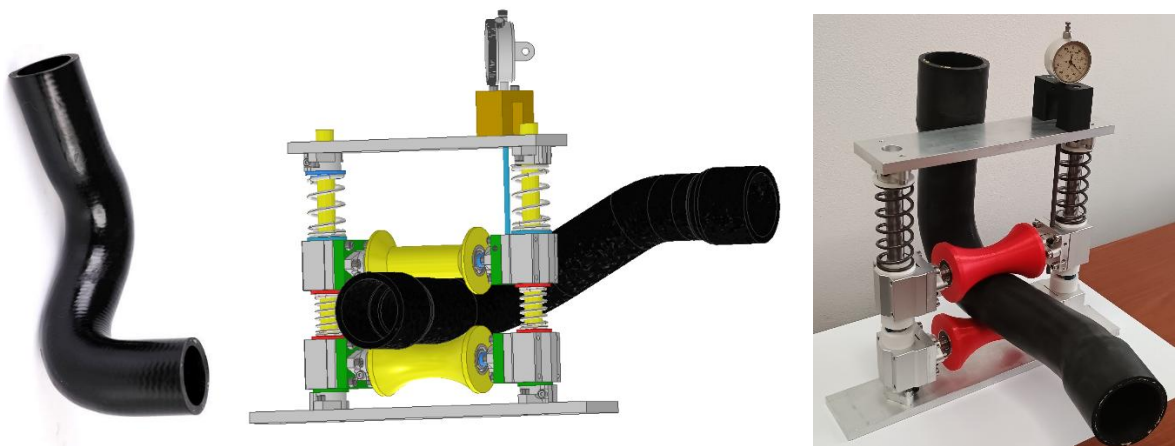

Fig. 1 a) Ideal dispersion, b) 3D blade design, c) 2D simulation of new blade type

### REFERENCES

- [1] Bandyopadhyay, Samar. "Chapter 1 Fundamentals of rubber compounding". Rubber Products: Technology and Cost Optimisation, edited by Bireswar Banerjee, Berlin, Boston: De Gruyter, 2024, pp. 1-52. <https://doi.org/10.1515/9783110668537-001>
- [2] STASIAK-BETLEJEWSKA, Renata a ALI, Abid. The Product and Process Quality Level Analysis in the Automotive Elements Production Management. Online. Management Systems in Production Engineering. 2024, roč. 32, č. 4, s. 514-524. ISSN 2450-5781. Dostupné z: <https://doi.org/10.2478/mspe-2024-0049>. [cit. 2025-05-31].
- [3] RAZZAQ, Ahsan; AIZED, Tauseef; AMEER, Muhammad Faizan; KHAN, Sami Ullah; KHAN, M. Ijaz et al. Failure mode and effects analysis of suction hose manufacturing industry: a case study of automobiles. Online. International Journal on Interactive Design and Manufacturing (IJIDeM). 2024, roč. 18, č. 9, s. 6809-6824. ISSN 1955-2513. Dostupné z: <https://doi.org/10.1007/s12008-024-01849-4>. [cit. 2025-05-31].

## **THE EFFECT OF PRINTING PARAMETERS ON THE CONDUCTIVITY OF CONDUCTIVE FILAMENTS IN THE 3D PRINTING PROCESS**

**STARÝ František<sup>1</sup>, MALÍKOVÁ Marie Jennifer<sup>1</sup>, ŠVEC Pavel<sup>1</sup>, DAVID Jiří<sup>1</sup>,  
BROM Pavel<sup>2</sup>, DYNBYL Vojtěch<sup>1</sup>.**

<sup>1</sup> Škoda Auto University, Department of Mechanical and Electrical Engineering, Na Karmeli 1457, 293 01 Mladá Boleslav, Czech Republic

<sup>2</sup> Škoda Auto University, Department of Quantitative Methods, Na Karmeli 1457, 293 01 Mladá Boleslav, Czech Republic

The paper analyses the correlation between the key printing variables, mainly the height of the layer and the volumetric speed on the resulting electrical properties.

In order to carry out the experiment, it was first necessary to determine the dependence of the electrical resistance on the magnitude of the tightening torque of the screw connection. For testing purposes, threads were physically cut into the samples from the conductive material. Different torques were applied using a torque wrench. After each tightening operation, the electrical resistance was measured by means of a precision ohmmeter. The aim of the methodology was to assess whether and how the magnitude of the mechanical load has an effect on the quality of the electrical contact and the resistance value.

In the experimental part, three different printing profiles were created, which differed in the printing parameters of layer height and printing speed. For each profile, ten identical conductive filament test samples were printed. The samples have been designed to allow accurate connection of the measuring electrodes and to minimise the error caused by contact resistance. After printing, individual samples were subjected to voltage-current characteristic measurements using a laboratory power supply and precision multimeter. The measurements were performed in a stable environment to ensure reproducibility of the results and eliminate the influence of ambient conditions. The resulting data was recorded and used to compare electrical properties between individual print profiles.

The results in this article extend the current knowledge in the field of additive manufacturing of functional materials (like in articles [1], [2] and [3]) and provide practical guidance for optimizing manufacturing processes aimed at achieving specific electrical properties in 3D printed components. The identified dependencies between printing parameters and electrical conductivity can be used to design and manufacture prototypes and functional parts with integrated electronics. Future research directions should include a more detailed analysis of the microstructure and distribution of conductive fillers in the polymer matrix in relation to the applied printing parameters, as well as an investigation of the influence of other process variables (layer overlap, fill density) and the potential of post-processing.

### REFERENCES

- [1] Aloqalaa, Z. "Electrically Conductive Fused Deposition Modeling Filaments: Current Status and Medical Applications" *Crystals*, 12(8), 2022 [online]. doi: <https://www.mdpi.com/2073-4352/12/8/1055>
- [2] Barik, R., Tanwar, V., Karla, P., Ingole P. P.. "Energy Materials for 3D Printing",. In: GUPTA, Ram K., ed. *3D Printing: Fundamentals to Emerging Applications*, 1st ed., CRC Press, Boca Raton, USA, 2023, pp. 49-64. ISBN 9781032283999, <https://doi.org/10.1201/9781003296676>
- [3] Probst, H., Katzer, K., Nocke, A., Hickmann, R., Zimmermann, M., Cherif, C. "Melt Spinning of Highly Stretchable, Electrically Conductive Filament Yarns" *Plymers* 13(4), 2021 [online]. doi: <https://doi.org/10.3390/polym13040590>

## MECHANICAL TESTING OF SLA MATERIALS TOUGH AND RIGID UNDER TENSILE AND FLEXURAL LOADS

STRUZ Jiri<sup>1</sup>, HRUZÍK Lukas<sup>1</sup>, SNIHOTTA Patrik<sup>1</sup>, PAVLIK Jan

<sup>1</sup> Faculty of Mechanical Engineering, VSB-Technical University of Ostrava, Department of Machine Parts and Mechanisms, 17. Listopadu 2172/15, 70800 Ostrava, Czech Republic

This work focuses on the mechanical testing of SLA (Stereolithography) resins Tough and Rigid, processed using Low Force Stereolithography (LFS) technology. The study evaluates the tensile and flexural behavior of these materials through standardized tests based on [1] and [2] procedures.

Specimens were printed using Formlabs<sup>®</sup> hardware under controlled conditions and post-processed with varying curing parameters. Mechanical responses were analyzed using stress–strain curves, and the data were interpreted using polynomial and bilinear regression models. Surface roughness was also measured to investigate its potential influence on mechanical performance.

The primary objective of this work is to create a comprehensive and validated material property database intended for designers and simulation engineers, providing realistic mechanical parameters for SLA materials. The resulting material models can be directly used in engineering analyses and numerical simulations, supporting more accurate design and performance predictions for 3D-printed components.

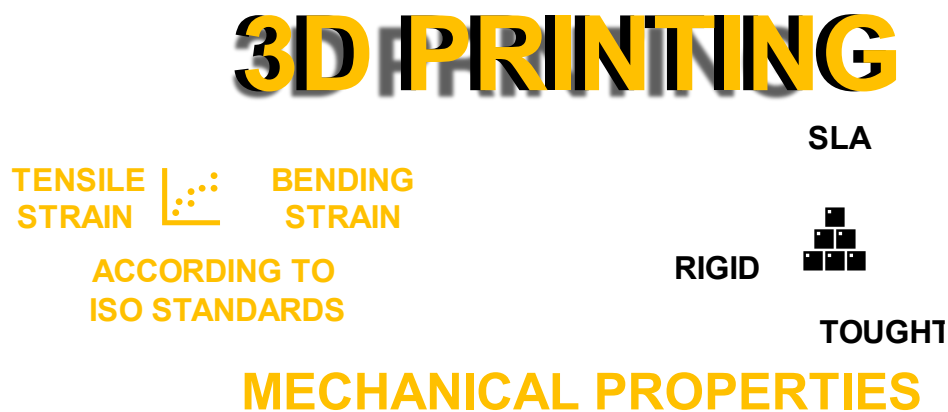

Fig. 1 Graphic abstract

### REFERENCES

- [1] ISO 527-2:2012, “Plastics - Determination of tensile properties - Part 2: Test conditions for moulding and extrusion plastics,” 2012, International Organization for Standardization.
- [2] ISO 178:2019, “Plastics — Determination of flexural properties,” 2019, International Organization for Standardization.

## **APPLICATION OF REVERSE ENGINEERING AND TOPOLOGY OPTIMIZATION IN MOTORCYCLE COMPONENT DEVELOPMENT WITH RAPID PROTOTYPING SUPPORT**

**ŠALKOVIČOVÁ Terézia<sup>1</sup>, ONDRUŠKA Juraj<sup>1</sup>, KOREC Filip<sup>1</sup>, PROTASOV Roman<sup>1</sup>**

<sup>1</sup> *Faculty of Mechanical Engineering, Slovak University of Technology in Bratislava, Institute of Automotive Engineering and Design, Nám. slobody 17,812 31 Bratislava, Slovakia*

This work focuses on the implementation of a comprehensive approach incorporating reverse engineering, topology optimization, and additive manufacturing for the design and fabrication of complex-shaped components with specified strength and stiffness characteristics under mass minimization constraints. A rear swingarm of a sport motorcycle was selected as the research object [1, 2]. The low-volume nature of motorcycle manufacturing and the need for frequent modernizations make additive technologies economically attractive through the elimination of expensive tooling and reduction of development time [3].

The initial swingarm model was obtained through three-dimensional scanning of the actual component, followed by the creation of a parametric model based on the scan data. Topology optimization was performed in the 3DEXPERIENCE system considering multiple loading scenarios, stress and deformation constraints, as well as additive manufacturing technological limitations [4, 5]. Results verification involved conducting physical experiments on a manufactured prototype to determine stiffness under design loads and comparing measured values with those obtained from FEA modeling. Analysis of the obtained data showed a discrepancy between numerical simulation results and experimental data of less than 5%.

The presented approach demonstrates significant potential for modernizing existing components and creating specialized modifications. This enables the creation of components with specified characteristics for machine assemblies where mass and size minimization are priorities, and the advantages of additive manufacturing justify their cost through achievable component geometry, reduced manufacturing time, and minimization of finishing operations.

The research presented in this paper is an outcome of the project VEGA No. 1/0708/24 “Research on the design parameters of the high-speed spinning spindle of the progressive concept” and the Slovak Research and Development Agency under Contract No. APVV-24-0641 “Research on hybrid electro-pneumatic spindle for high-speed machining with AI support.”

### REFERENCES

- [1] Lkadi, O., Nassraoui, M. Optimization of Lightweight Components through Hybrid Topology Optimization and Generative Design in Additive Manufacturing. *Key Engineering Materials*. 1018., 2025. DOI:10.4028/p-jWOR8x.
- [2] Zhang, Qiang & Li, Wenjie & Yang, Jifeng. Application Prospect Analysis of 3D Printing Technology in Industrial Manufacturing. *International Journal of Computer Science and Information Technology*. 4. 1-6. 2024, DOI:10.62051/ijcsit.v4n2.01.
- [3] Cézová E. "Economical and Statistical Optimization of the Maintenance in the Production Process", *Manufacturing Technology* 23 (1), 2023. ISSN 2787–9402
- [4] Olingheru, Răzvan-George, Olariu, Adrian-Bogdan, Miclosina, Călin-Octavian. Simulation of a serial topology robot operation using the 3DEXPERIENCE platform. *Studia Universitatis Babeş-Bolyai Engineering*. 69. 87-94. 2024, DOI:10.24193/subbeng.2024.1.8.
- [5] Jenis, J., Ondriga, J., Hreck, S., Brumercik, F., Čuchor, M., Sadovsky, E. Engineering Applications of Artificial Intelligence in Mechanical Design and Optimization. *Machines*. 11. 577. 2023 DOI:10.3390/machines11060577.

## NEW PRINCIPLE OF COOLING SYSTEM OF BATTERY CELLS

ŠEVČÍK Ladislav <sup>1</sup>, PETRŮ Michal <sup>1</sup>

<sup>1</sup> Faculty of Mechanical Engineering, Technical university of Liberec, Department of machine design, Studentská 2, 461 17 Liberec, Czech Republic

The paper deals with a new original method of cooling battery cells, especially for car batteries. In this case, the cells have the shape of a cylinder. Fig.1 shows a prototype of a small vehicle battery, consisting of 28/14-2 cells (14 cells in series, two in parallel). On the left is a section of the complete CAD model, on the right is the battery without a lid and terminal blocks. The battery terminals are 60V.

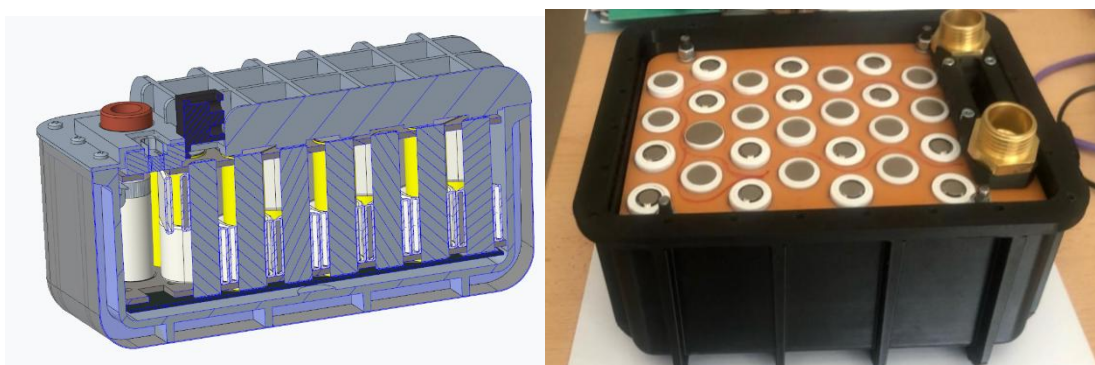

Fig.1 Small vehicle battery prototype, CAD model on the left, real part on the right

A battery was designed that is cooled by a fluid (gas-press air, liquid-fridex), flowing through a hyper elastic channel winding between the cells. Cooling is two-way, i.e. first along the lower part of the cells in the direction and back along the upper part of the cells in the opposite direction. The cells are wrapped  $2 \times 290^\circ$  - top and bottom. On one cell there is a helix of a cooling medium tube, so that cooling can be achieved from the bottom to the top. As a result, each of the cells has the same average cooling temperature. The distances between the cells are standard distances used in industrially manufactured batteries. The hyper elastic pipe is 0.5 mm thin, the diameter is  $2 \times 30$  mm, so the smallest distance between the batteries is 6 mm.

The advantage of this system is the controllability of the heat exchange surface based on the overpressure of the cooling medium in a hyper-elastic, flexible channel. In the case of a greater demand for heat dissipation, the pressure in the channel increases, and therefore the girdling of the cells. The cooling is counter-directional, easy to manufacture and assemble. The channel is electrically non-conductive. The paper performs a strength calculation of the cooling pipe.

### REFERENCES

- [1] F. Al ZHRANI, A. AL-SULAIMAN A review of battery thermal management systems for electric and hybrid electric vehicles. Renewable and Sustainable Energy Reviews, 2021 DOI: 10.1016/j.rser.2021.110974.
- [2] DINCER, Ibrahim, HAMUT, Halil S. a ZAMFIRESCU, Calin. Thermal Management of Electric Vehicle Battery Systems. Hoboken, NJ: Wiley, 2017. ISBN 978-1-119-08378-5.
- [3] PESARAN, A. a SANTHANAGOPALAN, S. Thermal management of lithium-ion batteries: A review of the state of the art. Applied Thermal Engineering [online]. 2019, 158, 114572 [cit. 2025-05-16]. Dostupné z: <https://doi.org/10.1016/j.applthermaleng.2019.114572>

## **WEAR OF NANO-COATINGS APPLIED IN THE TRANSMISSION MECHANISMS**

**TÓTH František<sup>1</sup>, KADNÁR Milan<sup>1</sup>, HARNIČÁROVÁ Marta<sup>2</sup>, VALÍČEK Jan<sup>2</sup>,  
TKÁČ Zdenko<sup>3</sup>**

<sup>1</sup> Faculty of Engineering, Slovak University of Agriculture in Nitra, Institute of Design and Engineering Technologies, Trieda Andreja Hlinku 2, 949 76 Nitra, Slovakia

<sup>2</sup> Faculty of Engineering, Slovak University of Agriculture in Nitra, Institute of Electrical Engineering, Automation, Informatics and Physics, Trieda Andreja Hlinku 2, 949 76 Nitra, Slovakia

<sup>3</sup> Faculty of Engineering, Slovak University of Agriculture in Nitra, Institute of Agricultural Engineering, Transport and Bioenergetics, Trieda Andreja Hlinku 2, 949 76 Nitra, Slovakia

The proposed scientific paper presents research focused on experimental testing of gear transmissions on a Nieman type test rig, while the parameters of wear and tooth surface roughness were analyzed. The gears were made of 42CrMoS4+QT (15 142) material and subsequently surface treated by nitriding, achieving a hardness of 580–600 HV5 for the pinion and 654–658 HV5 for the wheel. Two pairs of gears were subsequently deposited with a PVD coating of the nACRo4 type. Two types of lubricants were used during testing – conventional mineral oil PP 80 and biodegradable oil Carter Bio 150. The aim of the research was to monitor the roughness and wear rate of the contact surfaces of selected teeth between gears with and without PVD coatings. The tooth wear was monitored at two characteristic points: at the tip and reference diameter of the tooth to evaluate the influence of the load distribution on the extent of damage. The loading experiments were performed according to the STN 65 6280 standard. After each load test, the surface roughness value was measured; exceeding the specified limit value was an indicator of seizure. Subsequently, after the end of the loading experiments, detailed observations and analyses were performed using a JEOL JSM-IT300 scanning electron microscope and EDS analysis using an Oxford Instruments X-Max 20 spectrometer. The contact surfaces at the points of mutual contact of the teeth were compared - the reference diameter of the pinion with the reference diameter of the wheel, the tip diameter of the wheel with the root diameter of the pinion and the root diameter of the wheel with the tip diameter of the pinion. The measured results were statistically evaluated and processed into graphical dependencies between the degree of loading and the height of the Rz profile. To illustrate the course of wear processes, the oil temperature was recorded for individual pairs. The research is closely related to the completed monograph (1) and scientific publication (2), which deal in more detail with the issue of PVD coatings on gear transmissions and their influence on tribological properties and component life.

### **REFERENCES**

- [1] Tóth, F., Tulík, J., Kosiba, J. Laboratórny výskum povrchov s deponovanou vrstvou tenkých kovových filmov v oblasti tribologického systému. 1. vyd. Nitra: Slovenská poľnohospodárska univerzita, 2021. 163 s. ISBN 978-80-552-2372-8.
- [2] Fürstzeller, A., Tóth, F., Kadnár, M., Rusnák, J., Bošanský, M. Comparison of PVD coating nACRo4 and TiAlN + DLC deposited on high contact ratio gearing interacting with conventional and ecological lubricants. In Acta technologica agriculturae. ISSN 1335-2555, 2019, vol. 22, no. 2, p. 48-55. Available at: <https://dx.doi.org/10.2478/ata-2019-0009>.

## DESIGN, STRENGTH ANALYSIS AND PRODUCTION OF GEARS FOR MINING MACHINES

**PERMJAKOV Oleksandr<sup>1</sup>, KLOCHKO Oleksandr<sup>1</sup>, USTYNENKO Oleksandr<sup>1</sup>,  
RIABCHENKO Serhii<sup>2</sup>, DERGOUSOV Vadym<sup>3</sup>, BEREZHNYI Roman<sup>3</sup>,  
NEZHEBOVS'KYI Volodymyr<sup>3</sup>, UDOVIKOV Yurii<sup>4</sup>**

<sup>1</sup> *Institute of Education and Science in Mechanical Engineering and Transport,  
National Technical University "Kharkiv Polytechnic Institute", 61002 Kharkiv, Ukraine*

<sup>2</sup> *Department of Technologies for forming structured instrument composites,  
V.N. Bakul Institute for Superhard Materials, 04074 Kiev, Ukraine*

<sup>3</sup> *"Svitlo Shahtarya JSC", 61001 Kharkiv, Ukraine*

<sup>4</sup> *Geroiv Kosmosu MG PSD of DTEK Pavlogradcoal PrJSC,  
51453 Village Verbky, Pavlogradskiy district, Dnipropetrovsk region, Ukraine*

The current state of the Ukrainian fuel and energy complex requires a continuous increase in coal production. Currently, 80% of coal deposits are in thin seams. To solve this problem Ukrainian plants created and introduced into serial production a new generation of coal shearers [1]. An example of a new design is UKD200-500 coal shearer. It is designed for mechanized coal extraction as part of mining complexes, in longwalls of shallow and inclined seams 0.85–1.5 m thickness, moving along strike with inclination angles up to 35°, as well as rise and fall with angles up to 10°, with coal cutting resistance up to 480 kN/m. Its technical characteristics are at the level of modern foreign counterparts.

UKD200-500 coal shearer is a cutting action machine equipped with auger executive bodies for destruction and loading of coal onto a conveyor – Fig. 1. Moving the shearer with a scraper conveyor is carried out by means of an external feed system.



Fig. 1 The UKD200-500 coal shearer

The most loaded elements of mining machine are gears of cutting part. Calculations of gears strength and durability have been carried out. The modelling of the teeth stress-strain state by the finite element method also has been carried out [2].

Investigations of the processes of blade processing of gears and shafts of gearboxes of coal combines were carried out [3]. The state of the surface layer, the quality and accuracy of processing these parts with a blade tool made of superhard materials are determined. Research for grinding of an involute profile of gear wheels of gearboxes of mining machines is carried out. The influence of processing processes with a tool made of superhard materials on the strength and durability of gear drives of mining machines is determined.

The developed design of the gearbox for the cutting part of the combine provides the necessary durability of 15 000 hours and an average resource before overhaul.

### REFERENCES

- [1] "Konceptija rozvytku vugil'noi' promyslovosti". Shvaleno rozporjadzhennjam Kabinetu Ministriv Ukrainy vid 7 lypnja 2005 r. No 236-r. Available at: <https://www.kmu.gov.ua/npas/18609693>
- [2] Koval'chuk, O., Berezhnyj, R., Nezhebovs'kyj, V., Ustynenko O. "Analysis of Tenseness and Durability of the Main Parts for the Cutting Part of UKD 200-500 Coal Shearer". *Cutting and Tools in Technological Systems*, 2021, No 95, pp. 71–79.
- [3] Koval'chuk, O., Nezhebovs'kyj, V., Permyakov, O, Klochko, O, Riabchenko S. "Processing of hardened cylindrical gear wheels of the cutting gearbox of the combine UKD 200-500". *Cutting and Tools in Technological Systems*, 2021, No 95, pp. 57–70.

## TOLERANCE ANALYSIS OF STRUCTURAL FUNCTIONAL GROUPS

VANĚK Václav<sup>1</sup>

<sup>1</sup> *UWB in Pilsen, Faculty of Mechanical Engineering, Department of Machine Design,  
Univerzitni 22, 301 00 Pilsen, Czechia*

In the field of development and design of technical systems (TS), firms are encountering increasing problems with the implementation of current methodologies, approaches and requirements of standards into ongoing design processes in their daily practice. The efficient use of new technologies and hardware resources introduced in firms creates enormous pressure for the emergence of new or updated methodologies, approaches and development tools, as the existing systems offered to the design practice are unable to respond flexibly and efficiently to the changing characteristics of TS and especially the requirements placed on them. Therefore, it is primarily necessary to undertake an appropriate re-evaluation of older, established and proven engineering problem-solving methodologies in order to increase the efficiency, progressivity and speed of outputs in an environment of ever-increasing demands for the optimal achievement of the parameters of the required properties of TS. However, this does not mean that old and outdated design techniques can be condemned in advance; on the contrary, what is still good and applicable should be adopted and applied purposefully and transformed to the level of the current state of knowledge.

The most widely used method of tolerance analysis (hereafter TA) is sometimes also referred to as the method of calculating maxima and minima. It is based on the condition of observing the required limit deviation of the closing element for any combination of the actual dimensions of the sub-elements. This method guarantees complete assembly and operational interchangeability of the mechanical parts. However, if a higher accuracy of the closing element is required, this leads to too small tolerances of the sub-elements, resulting in excessively high production costs.

This paper aims to provide designers with more powerful and flexible TA tools. By using the offered flexible tools, designers will gain knowledge that will enable them to optimize the properties of TA more effectively in an environment of rapid increase in the demands placed on them. This includes ensuring assembly, interchangeability, high accuracy, low production times, low costs and functionality at the required change in operating temperatures.

### REFERENCES

- [1] Vanek, V. et al. Geometric Specification of Complex Spatially Oriented and Compliant Components II. Editor: Slavomir Hrcak, Abstracts of 59th International Conference of Machine Design Departments, In: ICMD 2018 Demänovská dolina 11th - 14th September 2018, Place: University of Žilina, Faculty of Mechanical Engineering, Slovakia.
- [2] Vanek, V., Polak, R. Geometric Specification of Complex Spatially-Oriented and Compliant Components I. Editor: David Herak, Proceedings of 58th International Conference of Machine Design Departments, In: ICMD 2017 Prague 6th-8th September 2017, Place: Czech University of Life Sciences, Prague, 414 - 419 ISBN 978-80-213-2769-6 Author, F., Author, S., Author, T.: Book title. 2nd edn. Publisher, Location (1999).
- [3] Daniilidis, C., Eben, K., Lindemann, U.: A functional analysis approach for product reengineering. *Procedia Eng.* 9(9), 270–280 (2011).
- [4] SHIGLEY, Joseph Edward a MISCHKE, Charles R. Standard handbook of machine design. 2nd ed. New York: McGraw-Hill, 1996. xvi, [1500 s.]. ISBN 0-07-056958-4.
- [5] Hosnedl, et al. Design Science for Engineering Design Practice, In: Eds. Culley S. et al., Proceedings of the ICED 01, Vol. 3, 2001, Place: Glasgow, 363- 370, IMechE, London.
- [6] BENAVIDES, Efrén Moreno. Advanced engineering design: an integrated approach. Cambridge: Woodhead Publishing, 2012. Woodhead Publishing in mechanical engineering. ISBN 978-0-85709-093-5.

## ALTERNATIVE USE OF A FEATHER KEY FOR TORQUE TRANSFER

VEREŠ Matúš<sup>1</sup>, BRUMERČÍK František<sup>1</sup>, BAŠŤOVANSKÝ Ronald<sup>1</sup>, KOHÁR Róbert<sup>1</sup>, MADAJ Rudolf<sup>1</sup>, ŠTEININGER Ján<sup>2</sup>

<sup>1</sup> Faculty of Mechanical Engineering, University of Žilina in Žilina, Department of Design and Mechanical Elements, Univerzitná 8215, 010 26 Žilina, Slovakia

<sup>2</sup> Institute of Competitiveness and Innovations, University of Žilina in Žilina, Univerzitná 8215, 010 26 Žilina, Slovakia

Torque transmission in shaft–hub connections typically utilizes longitudinal keys due to their straightforward design, reliable performance, and widespread applicability in various load scenarios. However, conventional longitudinal key designs often involve complex manufacturing processes, requiring specialized equipment such as broaching, shaping, or electro-discharge machining, significantly increasing production complexity, time, and cost

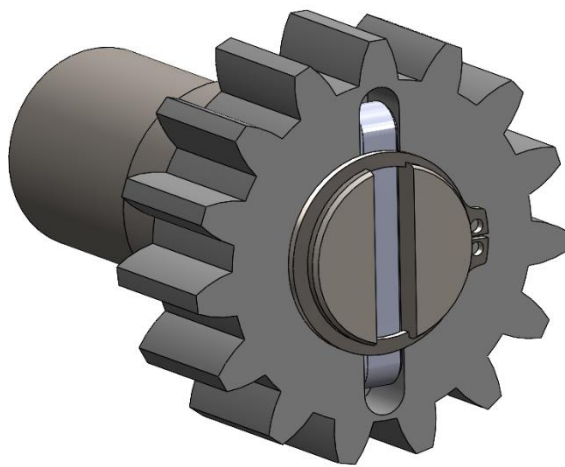

Fig. 1 - The view of the proposed joint

torque transmission capacities, revealing that despite the inherent reduction in effective load-bearing surfaces, transverse keys provide notable manufacturing, economic, and operational advantages. Comparative evaluations demonstrate that transverse keys effectively balance production simplicity with mechanical performance, particularly advantageous in situations characterized by limited hub widths. Additionally, experimental considerations suggest that transverse keys can offer improved cost-effectiveness without significantly compromising durability. Nonetheless, tolerance analysis underscores potential clearance concerns impacting fatigue performance, emphasizing the necessity of precise fit selection, rigorous quality control, and careful design optimization. Ultimately, this method represents a promising alternative for optimizing torque transmission solutions, particularly within spatially, economically, and technically constrained mechanical engineering applications.

[1,2]. Moreover, these methods frequently introduce stress concentrations and require skilled operators, further elevating the manufacturing overhead. Addressing these limitations, this research introduces an innovative approach termed transverse key placement, repositioning the key perpendicularly to the rotational axis, thereby creating a configuration resembling a pin joint. This new method markedly simplifies the manufacturing process by leveraging basic milling operations, thus becoming highly accessible even for smaller production facilities or workshops.

Analytical methods adapted from established pin-joint models quantify the

## REFERENCES

- [1] Grote, K.-H.; Hefazi, H. Shaft-Hub Connections. In Springer Handbook of Mechanical Engineering, 2nd ed.; Springer: Berlin/Heidelberg, Germany, 2021; pp. 551–566, ISBN 978-3030470340.
- [2] Pedersen, N.L. Optimal key design for shaft hub connections. Proc. Inst. Mech. Eng. Part C J. Mech. Eng. Sci. 2024, 238, 811–821.

## BLADE DESIGN OPTIMIZATION FOR ABRASIVE BLASTING APPLICATIONS

VOSÁHLO Josef<sup>1</sup>, SRB Pavel<sup>1</sup>

<sup>1</sup> Faculty of Mechanical Engineering, Technical University of Liberec, Department of Machine Parts and Mechanism, Studentská 2, 46001 Liberec, Czech Republic

**Abstract:** The paper focuses on the analysis of the operation of a straight-bladed jet turbine. Depending on the circumferential speed of the turbine, the relative velocities of the abrasive particles and their effects on the target area were investigated. A complex 3D model of the blast turbine was created based on the given parameters. To optimize the abrasive distribution on the leading edge of the blades, modifications were made to their geometry. To simplify the finite element method (FEM) calculations, the model was converted into 2D form. The input turbine speed parameters, particle properties and abrasive flow were then input to the model. The simulation captures the entire process of abrasive movement - from its entry into the turbine, through its interaction with the leading edge of the blades, to its impact on the target surface. The modelling results provide detailed records of impact locations and particle velocities.

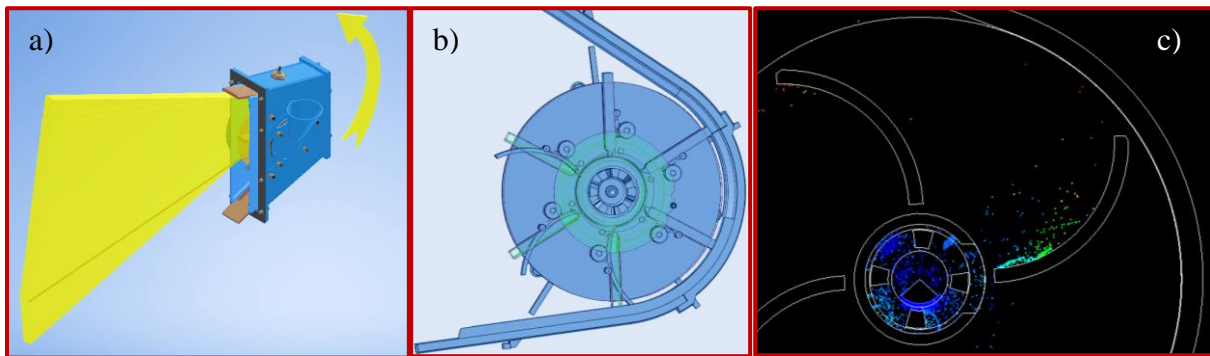

Fig. 1 a) Ideal dispersion, b) 3D blade design, c) 2D simulation of new blade type

### REFERENCES

- [1] Majchrak, M., Kohar, R., Kajan, J., Skyba, R.: 3D Meshing methods of ball-rolling bearings. In: Transportation Research Procedia 40, 784–791 (2019).
- [2] Majchrak, M., Kohar, R., Lukac, M., Skyba, R.: Creation of a Computational 2D Model of Harmonic Gearbox. In: Medvecký S., Hrcek S., Kohar R., Brumercik F., Konstantova V. (eds.) Current Methods of Construction Design: Proceedings of the ICMD 2018, LNME, pp. 95–103. Springer Nature Switzerland AG, Cham (2020).
- [3] Glowacz, A., Daviu, J. A. A.: Signal processing and analysis of electrical circuit. Electronics 9(1), 17 (2020).
- [4] Medvecký, S., Kohar, R., Hrcek, S.: Dynamic analysis of cage behavior in a tapered roller bearing. In: 7th International Symposium on Machine and Industrial Design in Mechanical Engineering, KOD 2012, pp. 45–50. University of Novi Sad, Novi Sad (2012).
- [5] Glowacz, A., Glowacz, W., Glowacz, Z., Kozik, J., Gutten, M., Korenciak, D., Khan, Z. F., Irfan, M., Carletti, E.: Fault diagnosis of three phase induction motor using current signal, MSAF-RATIO15 and selected classifiers. Archives of metallurgy and materials, 62(4), 2413–2419 (2017).
- [6] Gutten, M., Korenciak, D., Kucera, M., Janura, R., Glowacz, A., Kantoch, E.: Frequency and time fault diagnosis methods of power transformers. Measurement science review, 18(4), 162–167 (2018).
- [7] Drbul, M., Martikan, P., Broncek, J., Litvaj, I., Svobodova, J.: Analysis of roughness profile on curved surfaces. In: Innovative technologies in engineering production (ITEP'18), 244, 01024 (2018).
- [8] J. Vosáhlo, P. Srb, Numerical analysis of the velocity of abrasive particles in an abrasive blasting device., Proceedings of the 62nd International Conference of Machine Design Departments, Zhengzhou, Atlantis Press China, ISBN: 978-94-6463-423-5, p. 139-146, 8 pages, ISSN: 2589-4943, [Online], 2024

## VIBRATION ENERGY REDISTRIBUTOR DESIGN AND CHARACTERISTICS IDENTIFICATION

ŽUĽOVÁ Lucia<sup>1</sup>, GREGA Robert<sup>1</sup>, KRAJŇÁK Jozef<sup>1</sup>, URBANSKÝ Matej<sup>1</sup>

<sup>1</sup> Faculty of Mechanical Engineering, Technical University of Košice, Department of Engineering for Design of Machines and Transport Equipment, Letná 9, 042 00 Košice

In mechanical drives of machines and devices, unwanted vibration energy is created, which needs to be reduced to minimum values [1-3]. Worldwide exist many approaches to its reduction, and one of them is a targeted energy transfer of vibration to a secondary device applied in mechanical drive, in which vibration energy is dissipated in a one way and irreversible manner [4-6]. The aim of the article is to present the design of this type of secondary device (Fig.1), and identification of its static and dynamic characteristics.

This work was supported by the following projects VEGA 1/0573/25, KEGA: 037 TUKE-04/2024 a 044TUKE-4/2024.

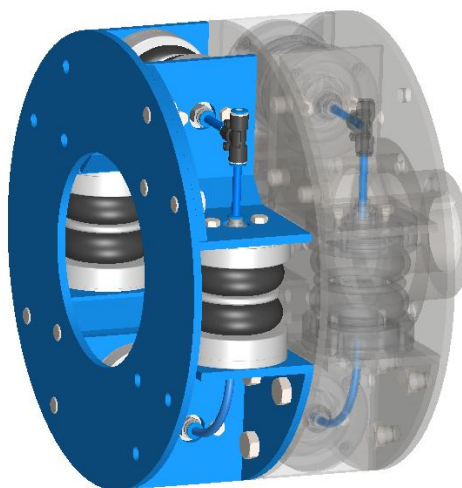

Fig. 1 Redistributor of vibration energy - 3D model

### REFERENCES

- [1] Žuľová L., Grega R., Kačír M.: Possibilities of vibration energy redistribution in mechanical drives using pneumatic flexible tuners. Applied mechanics 2024: book of articles. - Žilina (Slovensko): Žilinská univerzita v Žiline s. 200-204, ISBN 978-80-554-2090-5
- [2] Grega, R.; Krajnak, J.; Žuľová, L.; Kačír, M.; Kaššay, P.; Urbanský, M. Innovative Solution of Torsional Vibration Reduction by Application of Pneumatic Tuner in Shipping Piston Devices. J. Mar. Sci. Eng. 2023, 11, 261. <https://doi.org/10.3390/jmse11020261>
- [3] Žuľová L., et al.: Optimization of noisiness of mechanical system by using a pneumatic tuner during a failure of piston machine - 2017. In: Engineering Failure Analysis. Vol. 2017, no. 79(2017), p. 845-851. - ISSN 1350-6307
- [4] Chen, L.; Zeng, R.; Jiang, Z. Nonlinear dynamical model of an automotive dual mass flywheel. Adv. Mech. Eng. 2015, 7, 1687814015589533
- [5] Liu, C.C.; Jing, X.J.; Chen, Z. Band stop vibration suppression using a passive X-shape structured lever-type isolation system. Mech. Syst. Sig. Process. 2016, 68-69, 342-353.
- [6] Lee, H.J., Shim, J.K.: Multi-Objective optimization of a dual mass flywheel with centrifugal pendulum vibration absorbers in a single-shaft parallel hybrid electric vehicle powertrain for torsional vibration reduction. Mechanical Systems and Signal Processing 163, 2022

## Content

BEŇO Pavel, BRODNIANSKÁ Zuzana, LIPNICKÝ Marek

ENHANCING BRAKE STABILITY IN FLOATING CALIPER BRAKE ASSEMBLY  
THROUGH COMPLEX EIGENVALUE ANALYSIS:

A WEIGHTED BOLT APPROACH **6**

BERNÁTH Martin, DANKO Ján, BUCHA Jozef, DOBROVOLNÝ Juraj

CONCEPT OF A PARAMETRIC SIMULATION WORKFLOW FOR RUBBER-METAL  
MOUNTS IN ELECTRIC DRIVETRAIN APPLICATIONS **7**

BOŠANSKY Miroslav, PROTASOV Roman, ONDRUŠKA Juraj, VORONTSOV Borys,  
SOPRUNOV Igor

INVESTIGATION OF THE POSSIBILITY OF MODERNIZING EXISTING PLANETARY  
GEARS THROUGH THE USE OF GEARS WITH HCR ENGAGEMENT **8**

BUCHA Jozef, DANKO Ján, MAGDOLEN Ľuboš

VIRTUAL MODEL OF THE KYBURZ VEHICLE USING THE FMI STANDARD **9**

CÉZOVÁ Eliška

USE OF ARTIFICIAL INTELLIGENCE IN INSPECTION CALCULATIONS OF  
MACHINE COMPONENTS **10**

ČULÍK Ján

LIGHTWEIGHT COMPOSITE BUS STRUCTURES AND HYBRID HYDROGEN-  
ELECTRIC DRIVETRAINS FOR URBAN MOBILITY **11**

DAJBYCH Oldřich, SEDLÁČEK Aleš

ADVANTAGES OF COMBINING MECHANICAL ENGINEERING AND  
ELECTROTECHNICS KNOWLEDGE FOR THE MODERN ENGINEER **12**

DANKO Ján, MILESICH Tomáš, DOBROVOLNÝ Juraj, BERNÁTH Martin

NEW METHODOLOGY FOR THE DEVELOPMENT OF RUBBER-METAL ELEMENTS  
FOR ELECTRIC DRIVE UNIT MOUNTS **13**

DAVID Jiří, NOVOTNÝ Vojtěch, BROM Pavel, ŠVEC Pavel, BRADÁČ Josef

THERMOGRAPHIC DETECTION OF LIVING OBJECTS USING NEURAL  
NETWORKS **14**

DOBROVOLNÝ Juraj, DANKO Ján, MAGDOLEN Ľuboš,

IMPACT OF THE INPUT DATASET SIZE ON ACCURACY OF REDUCED ORDER  
MODELS OF RUBBER-METAL ELEMENTS **15**

DYNYBYL Vojtěch, STARÝ František, BRADÁČ Josef, DAVID Jiří, ŠVEC Pavel

DESIGN OF DRIVES FOR THE CORE DRILLING RIG	16
FLEK Jan, KARAS Tomáš, KADEŘÁBEK Petr,	
AUTOMATION OF GEAR MESH STIFFNESS MEASUREMENT USING OPEN-SOURCE TECHNOLOGIES	17
HERAK David, DAJBYCH Oldrich, KABUTEY Abraham	
BIOSYSTEMS ENGINEERING AND ITS INTERACTIONS WITH THE FUNDAMENTAL PRINCIPLES OF MECHANICAL ENGINEERING	18
HOŠTÁK Peter, ŠOOŠ Lubomír	
PARAMETRIC DESIGN OF THE STRUCTURAL ELEMENTS OF THE SPINDLE	19
CHRÍBIK Andrej, LUKNÁR Lukáš,	
EFFECT OF HIGH-ENERGY SYNGAS COMBUSTION UNDER CONSTANT CO <sub>2</sub> AND N <sub>2</sub> CONDITIONS	20
JANČO Roland	
NUMERICAL ANALYSIS OF CONTACT OF CONICAL PIPES	21
JÍROVÁ Radka, PEŠÍK Lubomír	
DYNAMIC ANALYSIS OF PASSENGER CAR REAR-VIEW MIRRORS	22
KABUTEY Abraham, MUSAYEV Mahmud, KIBRET Sonia Habtamu, SOE Su Su, DAJBYCH Oldřich, HERÁK David,	
COMPUTATION OF FITTING FUNCTIONS FOR DESCRIBING HEMP OIL OUTPUT PARAMETERS UNDER COMPRESSION LOADING	23
KAČÍR Matúš, GREGA Robert, URBANSKÝ Matej, ŽUĽOVÁ Lucia	
EXPERIMENTAL ANALYSIS OF NEW TYPE OF PNEUMATIC COUPLING	24
KANAVAL Antonín, DÍAZ-SALAMANCA Diego, MUÑIZ-CALVENTE Miguel, DUB Martin,	
MECHANICAL BEHAVIOUR OF SLOTTED BOLTED JOINTS IN PHOTOVOLTAIC PANEL ASSEMBLIES: A FINITE ELEMENT STUDY	25
MUÑIZ-CALVENTE Miguel, DÍAZ-SALAMANCA Diego, KANAVAL Antonín, KANAVAL Jan,	
FEM ANALYZES AND EXPERIMENTAL VERIFICATION OF THE LOAD CAPACITY OF PRESTRESSED BOLTED JOINTS OF PHOTOVOLTAIC PANELS DYNAMICALLY LOADED BY WIND	26
KEVICKÝ Igor, MAGDOLEN Ľuboš, MILESICH Tomáš, BERNÁTH Martin	
METHODOLOGY FOR CREATING AN OVERTAKING MANEUVER IN THE SIMULINK SIMULATION ENVIRONMENT	27

KLAPETEK Lukas,	
3D SCANNING IN ENGINEERING APPLICATIONS	28
KOZÁRIK Daniel, SMETANKA Lukáš, ŠTEININGER Ján, HRČEK Slavomír ,	
COMPARISON OF NONLINEAR FINITE ELEMENT SOLUTIONS FOR SEAL COMPRESSION USING STATIC AND TRANSIENT ANALYSIS	29
KUČERA Ľuboš, KOHÁR Róbert,	
ANALYSIS OF THE DESIGN OF A PROTECTIVE FRAME DEVELOPED FROM CARBON COMPOSITE	30
LUKNÁR Lukáš, CHRÍBIK Andrej	
OPTIMIZATION OF A BIOGAS-FUEL TURBOCHARGED COMBUSTION ENGINE USED IN AGRICULTURAL EQUIPMENT	31
ROMANIUK Vitalii, NATMELAZE Nino, MAŠČENIK Jozef, KRENICKÝ Tibor	
CONTROL OF BEAM DEFLECTION MEASUREMENT BY INDUCTIVE LINEAR TRANSDUCER	32
MILESICH Tomáš, KEVICKÝ Igor, BUCHA Jozef	
EFFICIENT FUSION OF DUAL LIDAR DATA STREAMS WITH MAINTAINED ORGANIZED STRUCTURE	33
RAJESH Mishra, VIJAY Chandan, MULLER Miroslav, JIRKU Petr, KOLAR Viktor, SHABNAM Nazari, IVANOVA Tatiana Alexiou	
COMPUTATIONAL AND ANALYTICAL STUDIES ON HYBRID COMPOSITES REINFORCED WITH BIO-FIBERS & FILLERS	34
ANTIĆ Jovana, MIŠKOVIĆ Žarko, PEJČIĆ Danilo, DIX Martin, PIERER Alexander, HEIDRICH Jürgen, MILBRANDT Matthias	
EFFECT OF MULTI-CYCLE CRYOGENIC TREATMENT ON THE HARDNESS OF ROLLING BEARING BALLS	35
NAGY Miroslav, GULAN Ladislav, KOREC Filip	
REDUCING FUEL CONSUMPTION AND EMISSIONS WITH THE HYBRIDIZATION OF THE UDS 132 MOBILE WORK MACHINE	36
NĚMČEK Miloš	
NOTE ON CALCULATION OF SERVICE LIFE OF GEAR WHEELS ACCORDING TO ISO 6336	37
ONDRUŠKA Juraj, PROTASOV Roman, BOŠANSKÝ Miroslav, BABICS Jozef	
EVALUATION OF COOLING PARAMETERS FOR HIGH-SPEED SPINDLES WITH HYBRID DRIVE	38

PETR Karel

APPLICATION OF GENERAL SPECIFICATIONS AND 3D SCAN VERIFICATION **39**

PROTASOV Roman, ONDRUŠKA Juraj, BOŠANSKÝ Miroslav, BABICS Jozef

INVESTIGATION OF A COMBINED SYSTEM FOR AXIAL PRELOAD OF HIGH-SPEED SPINDLE BEARINGS **40**

PUŠKÁR Michal, TARBAJOVSKÝ Pavol

COMBUSTION CHAMBER FOR HYDROGEN INTERNAL COMBUSTION ENGINES WITH DUAL INJECTION **41**

PUTALA Rastislav, FERENČEY Viktor

TRANSPORT PHENOMENA IN THE CATHODE TRACT OF A HYDROGEN PEM FUEL CELL **42**

SIGWARTH Claudia

DEVELOPMENT OF A STACK FOR VANADIUM REDOX FLOW BATTERIES **43**

SNIEHOTTA Patrik

DESIGN OF EQUIPMENT FOR CARBON CAPTURE **44**

SRB Pavel, VOSÁHLO Josef

DESIGN OF RUBBER HOSE DEFECT TESTING EQUIPMENT **45**

STARÝ František, MALÍKOVÁ Marie Jennifer, ŠVEC Pavel, DAVID Jirí, BROM Pavel, DYNBYL Vojtěch

THE EFFECT OF PRINTING PARAMETERS ON THE CONDUCTIVITY OF CONDUCTIVE FILAMENTS IN THE 3D PRINTING PROCESS **46**

STRUZ Jiri, HRUZÍK Lukas, SNIEHOTTA Patrik, PAVLIK Jan

MECHANICAL TESTING OF SLA MATERIALS TOUGH AND RIGID UNDER TENSILE AND FLEXURAL LOADS **47**

ŠALKOVIČOVÁ Terézia, ONDRUŠKA Juraj, KOREC Filip, PROTASOV Roman

APPLICATION OF REVERSE ENGINEERING AND TOPOLOGY OPTIMIZATION IN MOTORCYCLE COMPONENT DEVELOPMENT WITH RAPID PROTOTYPING SUPPORT **48**

ŠEVČÍK Ladislav, PETRŮ Michal

NEW PRINCIPLE OF COOLING SYSTEM OF BATTERY CELLS **49**

TÓTH František, KADNÁR Milan, HARNIČÁROVÁ Marta, VALÍČEK Jan, TKÁČ Zdenko

WEAR OF NANO-COATINGS APPLIED IN THE TRANSMISSION MECHANISMS **50**

PERMJAKOV Oleksandr, KLOCHKO Oleksandr, USTYNENKO Oleksandr,  
RIABCHENKO Serhii, DERGOUSOV Vadym, BEREZHNYI Roman, NEZHEBOVS'KYI  
Volodymyr, UDOVIKOV Yurii

DESIGN, STRENGTH ANALYSIS AND PRODUCTION OF GEARS FOR MINING  
MACHINES **51**

VANĚK Václav

TOLERANCE ANALYSIS OF STRUCTURAL FUNCTIONAL GROUPS **52**

VEREŠ Matúš, BRUMERČÍK František, BAŠŤOVANSKÝ Ronald, KOHÁR Róbert,  
MADAJ Rudolf, ŠTEININGER Ján

ALTERNATIVE USE OF A FEATHER KEY FOR TORQUE TRANSFER **53**

VOSÁHLO Josef, SRB Pavel

BLADE DESIGN OPTIMIZATION FOR ABRASIVE BLASTING APPLICATIONS **54**

ŽUĽOVÁ Lucia, GREGA Robert, KRAJŇÁK Jozef, URBANSKÝ Matej

VIBRATION ENERGY REDISTRIBUTOR DESIGN AND CHARACTERISTICS  
IDENTIFICATION **55**

CONTENT **57**

**Organizing Committee:**

Miroslav Bošanský  
Juraj Ondruška  
Miroslav Nagy  
Roman Protasov  
Terézia Šalkovičová  
Eliška Cézová